

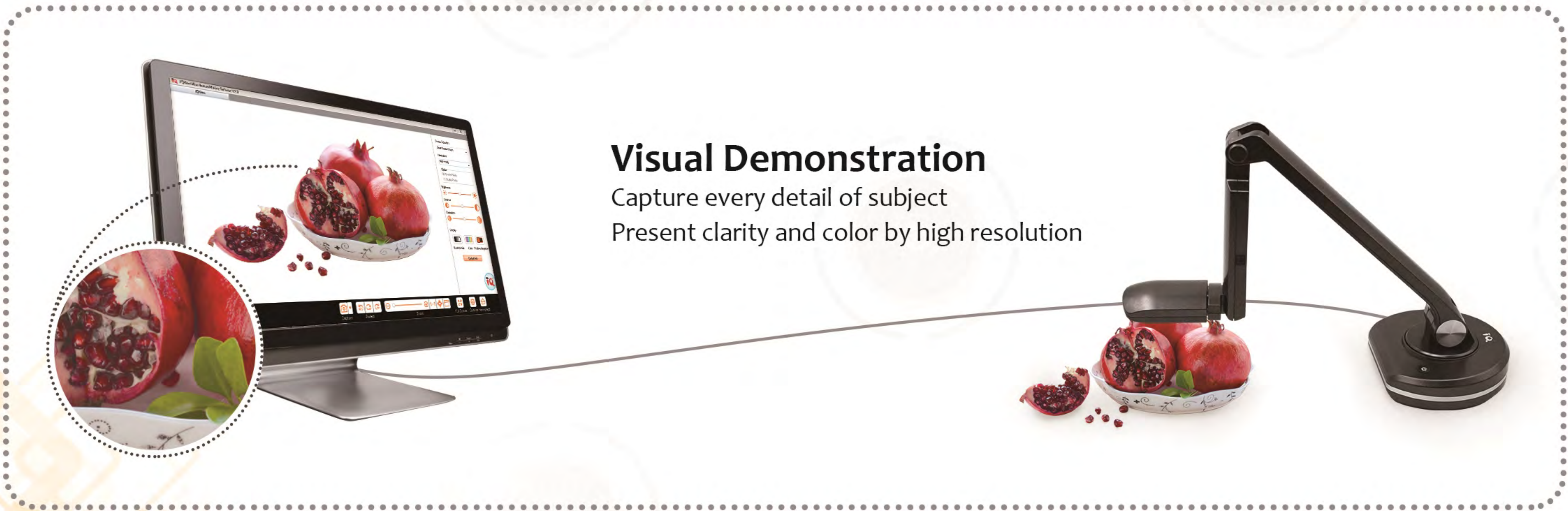

# IQView Interactive Document Camera E6510

## Multipurpose



### Products Highlights

- Flexible and smart design
- 8M pixels (3256x2440)
- Auto Focus
- Macro Shooting
- 11 LEDs with softbox
- Support IQView Software

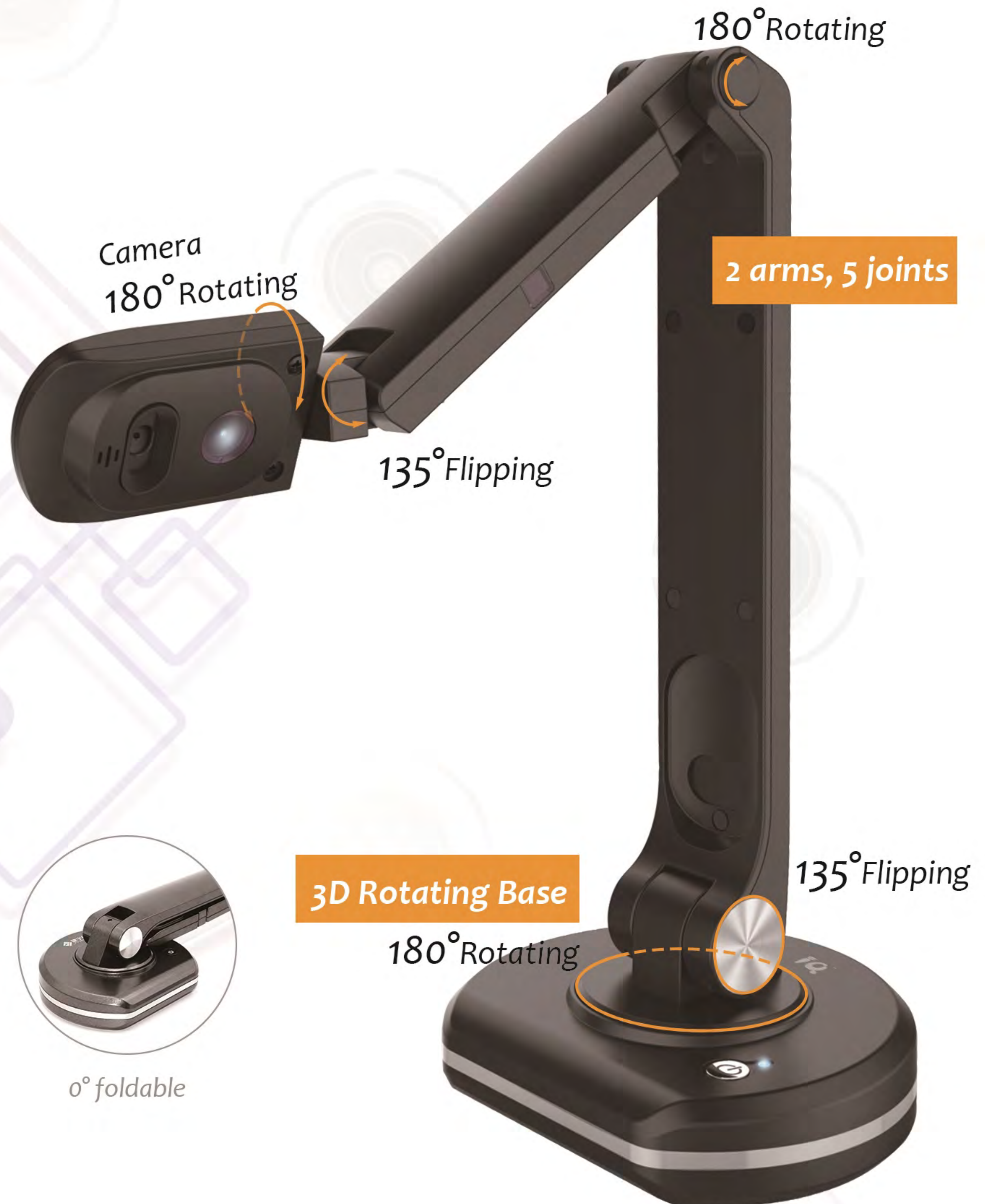

HD Camera



LED with Softbox



0° foldable

# IQView Interactive Document Camera E6510

## Software Features

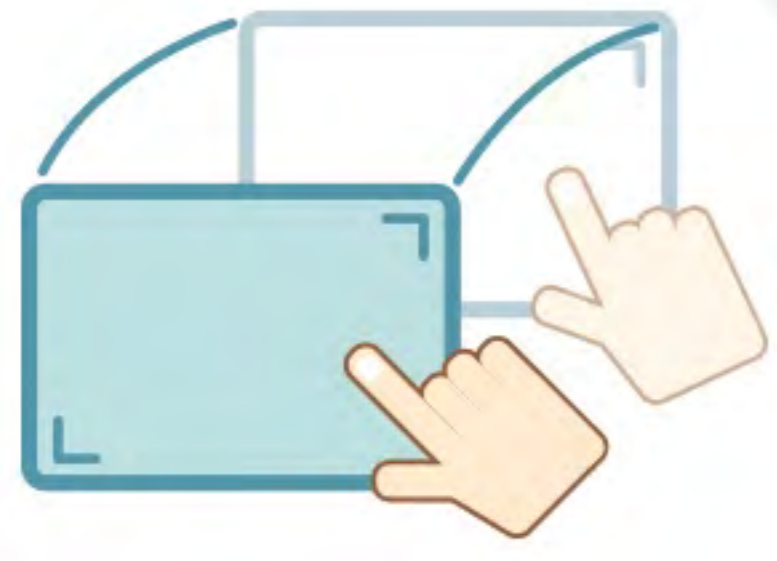

Image scroll



Zoom in/out



Image rotation



Image highlight



Screen recording







Real-time annotation

Model	E6510
Pickup Device	CMOS 1/4", 8 MP
Resolution	2591*1994 (5MP) 1280*960 (SXGA) 1280*720 (720p) 1920*1080 (1080p) 3256*2440 (8MP)
Digital Zoom	×10
Auto Focus	YES
Auto Exposure	YES
Auto White Balance	YES
Frame Rate	30fps
Scanning Area	Nearly A3
Rotation	Camera 270°, Arm 360°
Macro Shooting Distance	≤5cm
Light Source	11 LEDs with softbox
SNR	≥40db
Power Supply	USB2.0
Audio	Built-in MIC
Interface Ports	USB2.0
Integrated Software	IQView Micro-lecture Making Software
Operation System	Windows XP/Vista/7/8/10
Product Weight	976g
Product Size	W115mm * D75mm * H330mm



**IQ Authorized Dealer**

 IQ Board Australia  
 6 Lakewood Blvd, Carrum Downs Victoria, 3201 AUSTRALIA  
 1300 472 627 (1300 IQBOARD)  
 [www.iqboard.com.au](http://www.iqboard.com.au)  
 [enquiries@iqboard.com.au](mailto:enquiries@iqboard.com.au)