

IQTouch

TB1300 Pro

Interactive Flat Panel Display

—User Manual—







Content



Safety Instruction	4
1. Product Overview	9
1.1. Appearance Introduction	9
1.2. Ports	11
2. Installation	17
2.1. Safety Precautions	17
2.2. Installation Step	17
2.3. Weight Loading	20
2.4. OPS Installation	22
3. Getting Started	24
3.1. Power On	24
3.2. Power Off	25
4. IQ OS	27
4.1. Homepage	27
4.1.1. Start Guide	27
4.1.2. Introduction of Page Elements	28
4.1.3. Status Bar	29
4.1.4. Sidebar	30
4.1.5. Compass	31
4.1.6. Recent page	32
4.2. Whiteboard	33
4.2.1. Menu	34
4.2.2. Setting	35
4.2.3. Page Management	36
4.2.4. Paintbrush	36
4.2.5. Erase	37
4.2.6. Select	37
4.2.7. Insert	38
4.2.8. Undo and Redo	39
4.2.9. More	39
4.3. Screen Sharing	40
4.3.1. Operating instructions	40
4.3.2. Special instructions for multi-screen interaction interface	42
4.3.3. Webcast remote screen sharing	43
4.3.4. Laptop screen sharing	43
4.4. Mini Whiteboard	44
4.5. Annotation	45
4.5.1. Writing	45
4.5.2. Erase	45
4.5.3. Minimization	45
4.5.4. Close&Save	46







4.6. Applications	46
4.6.1. File Manager	46
4.6.2. Multi-window	48
4.6.3. Welcome page	49
4.6.4. Screen recording	50
4.6.5. Screenshot	51
4.6.6. Gallery	52
4.6.7. Voting System	52
4.6.8. Easy Upload	53
4.6.9. Timer	54
4.6.10. Multi-users	55
4.7. Android Settings	56
4.7.1. Network	56
4.7.2. General	59
4.7.3. Device	66
4.7.4. Input Channel	70
4.7.5. System	71
5. Serial Port	77
6. Troubleshooting	83

Safety Instruction

For your safety, please read the following instructions before you use the device. Serious injury or property damage may be caused by improper operations. Do not try to repair the device on your own.

 WARNING	
	<p>Disconnect the machine from power supply immediately if any major failures occur.</p> <p>Major failures include the following:</p> <ul style="list-style-type: none"> • Smoke, peculiar smell or abnormal sound is discharged from the device. • No image or sound is displayed, or the image error occurs. • Where the main plug or an appliance coupler is used as the disconnect device the disconnect device shall remain readily operable. <p>In the preceding scenarios, do not continue to use the machine. Disconnect power supply immediately and contact professional staff for troubleshooting.</p>
	<p>Do not drop liquid, metal or anything combustible onto the machine.</p> <ul style="list-style-type: none"> • If any liquid or metal is dropped into the machine, power off the machine and disconnect power supply, then contact professional staff for solutions. • Pay attention to children when they are close to the machine.
	<p>Put the machine on a stable surface.</p> <p>An unstable surface includes and is not limited to an inclined plane, a shaky stand, desk or platform, which might cause turnover and damage.</p>
	<p>Do not open the cover or change the machine on your own.</p> <p>High voltage components are installed in the machine. When you open the cover, high voltage, electric shock, or other dangerous situations may occur.</p>

	<p>If inspection, adjustment, or maintenance is required, contact the local distributor for help.</p>
	<p>Use the specified power supply.</p> <ul style="list-style-type: none"> • To prevent the machine from being damaged, do not use any cables other than the one provided with the machine. • Use a three-wire socket and ensure that it is properly grounded. • Pull out the power plug from the socket if the machine is not used for a long period.
	<p>Clean the power plug regularly.</p> <ul style="list-style-type: none"> • Continued use of this machine may cause fire or electric shock if the plug is not cleaned for a long time. • Pull out the power plug before cleaning it with a dried cloth
	<p>Power output port is 5V/2A</p>
	<p>Do not put items on the top of the machine.</p> <ul style="list-style-type: none"> • Do not put items, such as a container for liquid (a vase, flowerpot, cosmetics, or liquid medicine) on the top of the machine. • If any liquid such as water is spilled on the machine, the machine may short circuit and cause fire or electric shock. • Do not walk on or hang any items on the machine.
	<p>Do not install the machine in an improper place</p> <ul style="list-style-type: none"> • Do not install the machine in humid places, such as the bathroom, the shower room, near windows, or outdoor environments that experience rain, snow, or other harsh weather. Avoid installation near hot spring vapor. The preceding environments may cause faults in the machine or electric shock under extreme conditions.

	<ul style="list-style-type: none"> • Do not put an exposed fire source, such as a lit candle, on the machine.
	<p>Pull out the power supply during thunderstorms.</p> <ul style="list-style-type: none"> • Do not touch the machine during a lightning storm, you may experience an electric shock. • Install or place components that supply high enough voltage to cause personal injury out of the reach of children.
	<p>Do not touch the power cable with wet hands.</p>
 CAUTION	
	<p>Do not install the machine in high temperature environments.</p> <ul style="list-style-type: none"> • Do not install the machine near a heat source, such as a radiator, a heat reservoir, a stove, or other heating machines. • Do not expose the machine to direct sunlight, which may cause high temperatures and subsequent faults in the machine.
	<p>When transporting the machine:</p> <ul style="list-style-type: none"> • Pack the machine for transport or maintenance by using the cartons and cushioning material provided with the machine. • Move the machine vertically during transport. The screen or other components are easily broken if the machine is moved in an improper way. • Before you move the machine, disconnect all external connections. Move the machine carefully to prevent it from being hit or squeezed, especially the screen, which may cause injury if broken
	<p>Do not cover or block up any vents on the machine.</p> <ul style="list-style-type: none"> • Any overheated components may cause fire, damage the machine, and shorten the service life.

	<ul style="list-style-type: none"> • Do not lay the machine down in a way where the venting surface will be covered. • Do not install the machine on carpet or cloth. • Do not use a cloth, such as table cloth, to cover the machine
	<p>Keep the machine away from the radio.</p> <p>The machine complies with the international EMI standard to prevent radio interference. However, interference may still exist and cause noise in the radio. If noise occurs in the radio, try the following solutions.</p> <ul style="list-style-type: none"> • Adjust the direction of the radio antenna to avoid interference from the machine. • Keep the radio away from the machine.
	<p>Do not damage the power cable.</p> <ul style="list-style-type: none"> • Do not damage, change, twist, bend, or forcibly drag the power cable. • Do not put weights (such as the machine itself) on the power cable. • Do not forcibly drag the cable when you pull out the power plug. If the power cable is damaged, please contact the local distributor to repair or replace it. • The power cable in the accessory box is for this machine only, do not use it on other machines.
	<p>Use the battery correctly.</p> <ul style="list-style-type: none"> • Galvanic corrosion, electric leakage, and even fire may be caused by improper battery usage. • It is recommended to use the designated type of battery and install the battery with the correct electrodes (positive and negative). • Do not install and use a new battery with a used one. • Take out the battery if the remote control is not used for a long period.

	<ul style="list-style-type: none">• Do not expose the battery to overheated environments, such as sunlight or heat sources.• Dispose of the used battery based on your local regulations.
	<p>Additional advice:</p> <ul style="list-style-type: none">• Use the machine in an environment with comfortable lighting. It is harmful to your eyes to watch in a too bright or too dark environment.• Relax your eyes watching for a period of time.• Keep sufficient distance from the machine to protect your eyes and prevent eyestrain.• Adjust the volume to an appropriate level, especially at night.• Use amplifier equipment as the audio input source with caution. If you must use amplifier equipment, the input power should not exceed the maximum of speaker power. Otherwise, the speaker can become overpowered and damaged.
	<p>special remarks:</p> <ul style="list-style-type: none">• The machine can only achieve zero energy consumption when no external input power supply is connected. Therefore, it is recommended to turn off the device when not using it to reduce energy consumption.• On the premise of ensuring the viewing quality, energy consumption can be reduced by reducing the brightness of the display.• This machine can be used with all kinds of built-in computers, which can be upgraded or replaced according to your needs.

1. Product Overview

1.1. Appearance Introduction

Front View

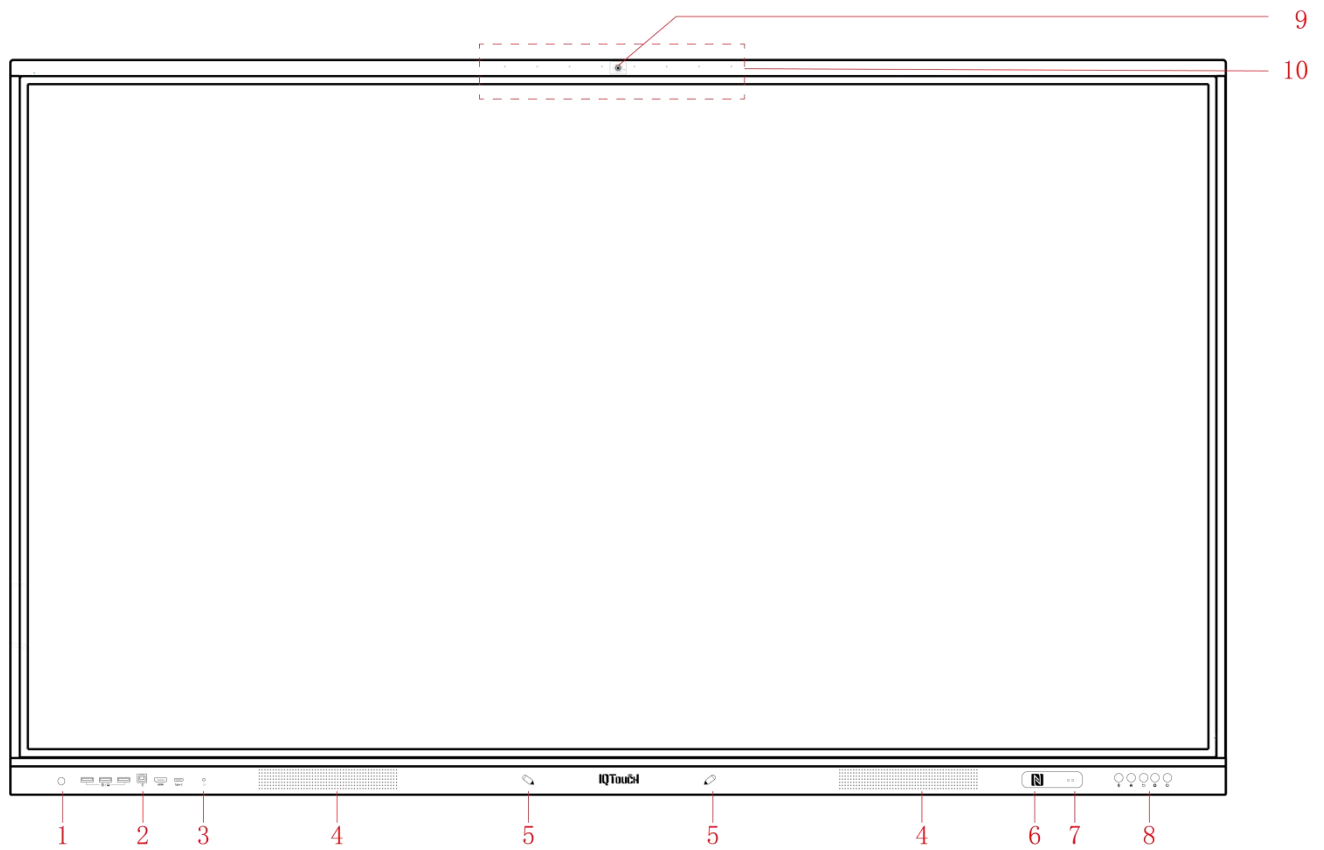

Rear View

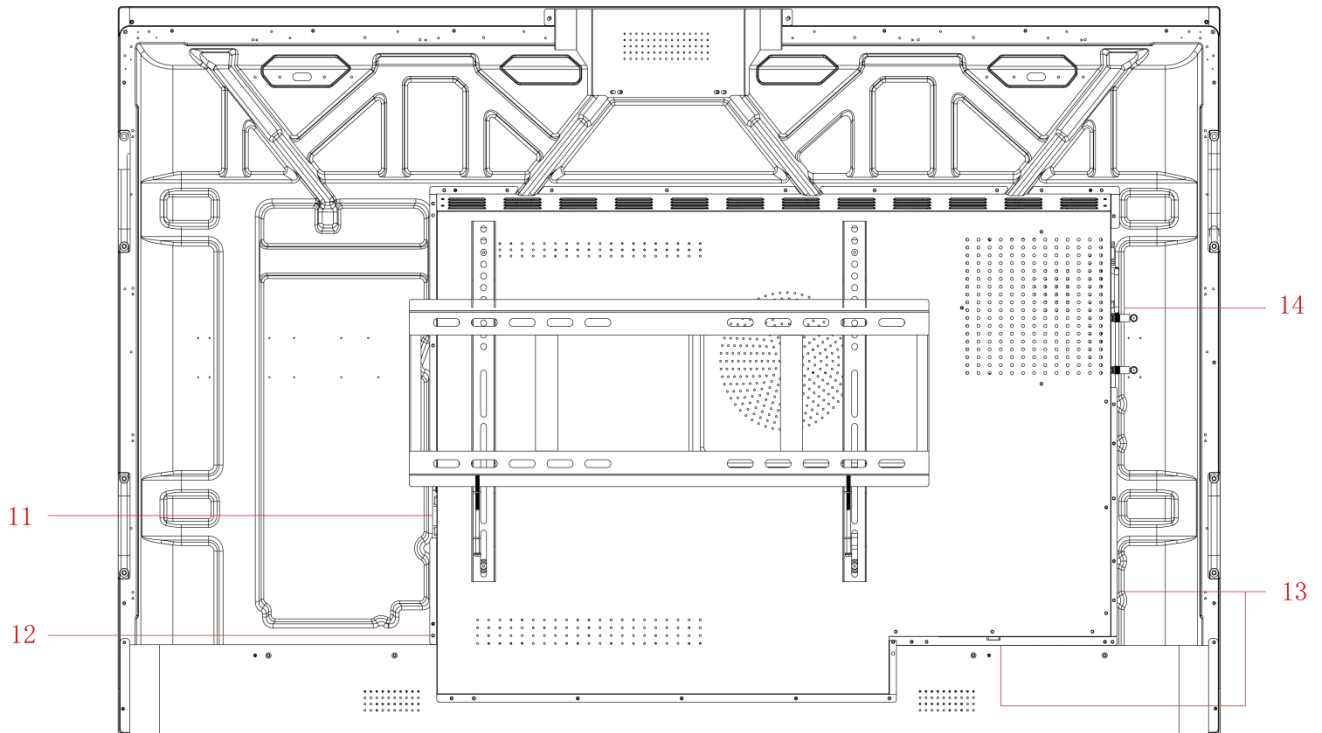

1	Proximity Sensor	8	Front Buttons
2	Front Ports	9	Top camera
3	Light Sensor	10	Microphone
4	Speakers	11	Power Supply Plug
5	Magnetic Pen Placement Area	12	Power Switch
6	NFC Card Area	13	Rear Ports
7	Remote Control Receiver	14	OPS Port

1.2. Ports







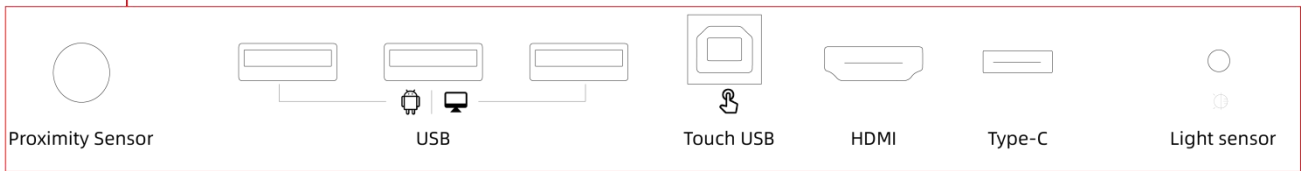
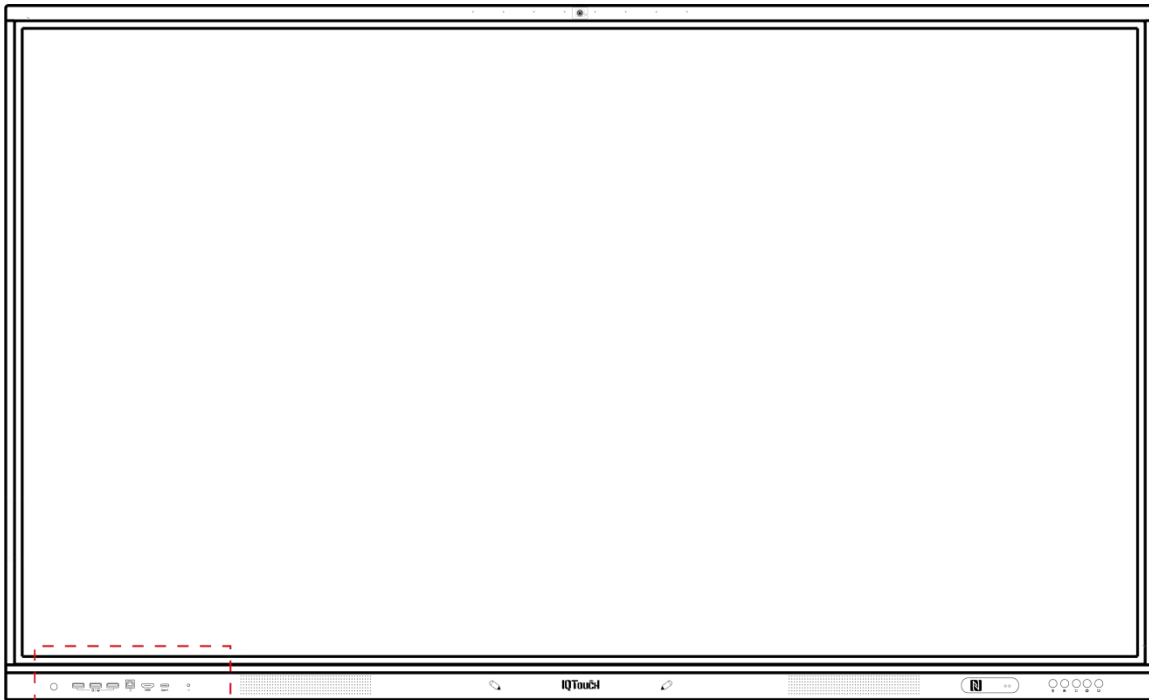

CAUTION

- *Front USB ports and rear USB 3.0/USB 2.0 ports switch connections based on signal sources. If the current signal source is reading the data from an external product connecting to the port, please switch the signal source after the data reading is complete. Otherwise, the data or product may be damaged.*
- *For USB use, USB 2.0 provides up to 500Ma whereas USB 3.0 provides up to 900Ma of power. Please make sure the USB flash drive is formatted to FAT32 before inserting it into the panel.*
- *Please use the supplied cable in the accessory box or the HDMI association certified shielded cable to better ensure the signal quality.*
- *While HDMI and Display Port offer support for cables of varying lengths, the maximum cable length that the panel recommends for optimal performance is 3 meters (10 feet) for HDMI and 1.8 meters (around 6 feet) for Display Port. Using cable longer than recommended length may cause data loss and a negative impact on display quality.*

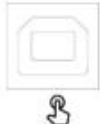
Front Ports



Item	Icon	Function Description
1	 Proximity Sensor	When the screen is in ECO mode, the screen will automatically wake up when a person approaches the screen within 3 meters.
2	 USB	USB 3.0 port (Andriod & PC)
3	 Touch USB	Realize touch function of external device

4	 HDMI	HDMI port used to connect an external display device
5	 Type-C	USB Type C: Image, power, touch, audio and video transmission
6	 Light sensor	Light sensor: Automatically adjust screen brightness according to ambient light



WARNING

The rear power output port supplies 5 V/2 A (maximum) power. Please purchase the power AC adapter for powering external devices. Please do not connect any products which require more power than listed. Doing so may cause injury or damage to the panel.



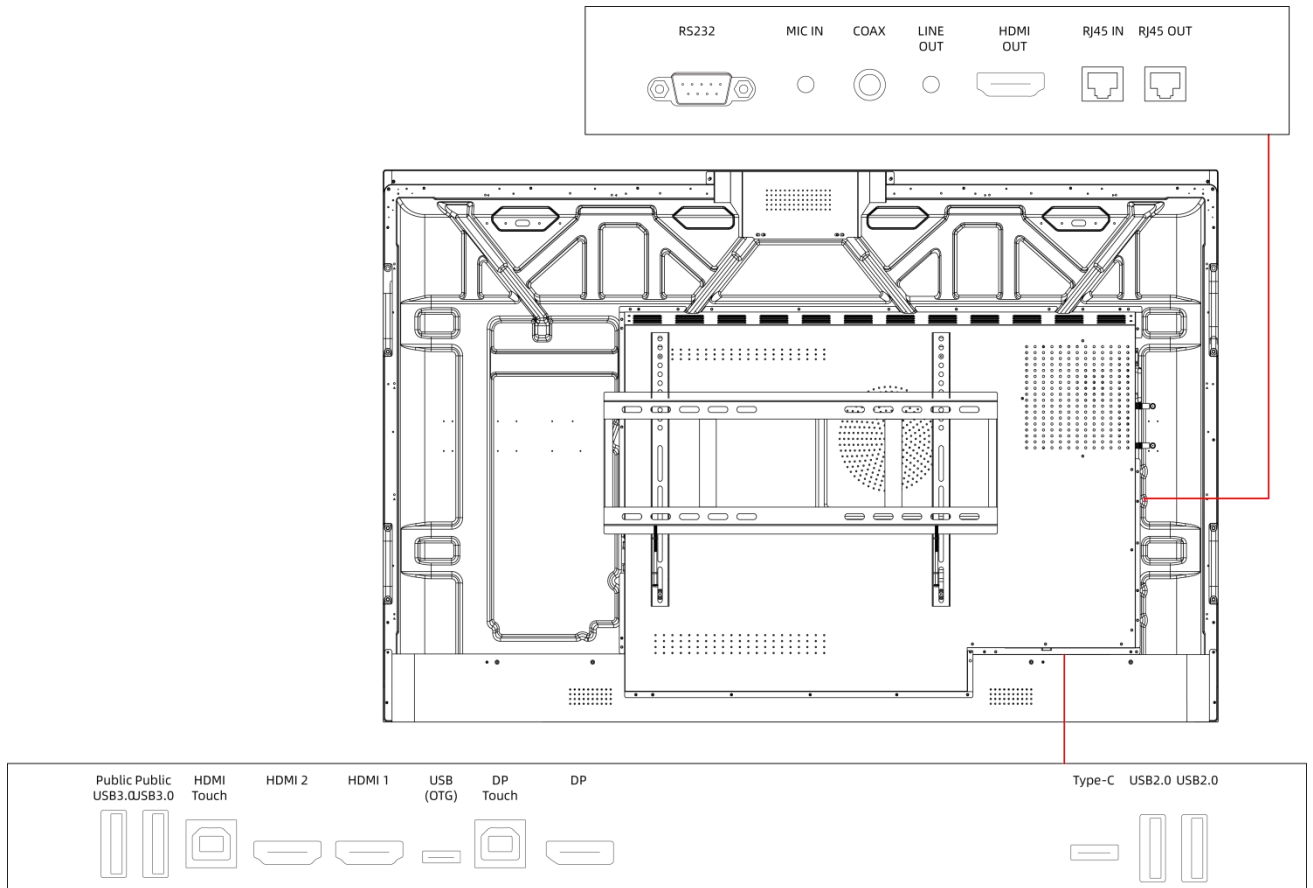

Rear Ports

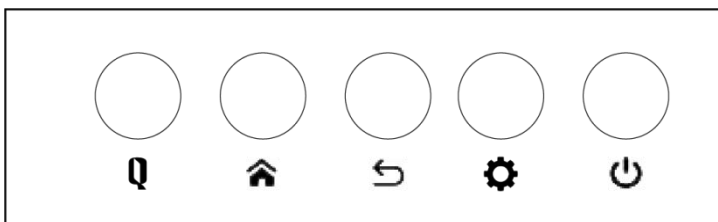

1.3 Front Buttons





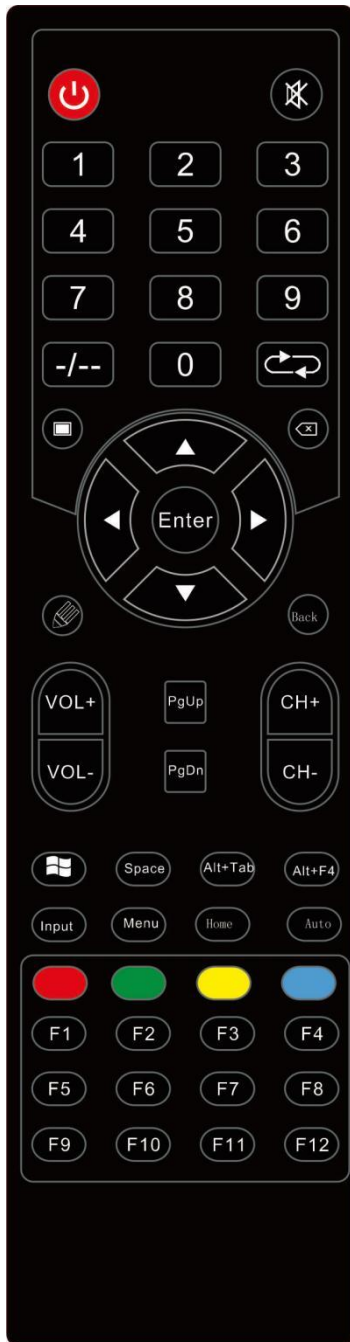

Buttons	Operations	Functions
Q	Short press	Enter the preset function. Note: Q button can be set in System Settings> General > Custom Key.

	Short press	Go to the home page.
	Short press	Back to the previous menu.
	Short press	Open the Quick Setting menu
	Short press	Power on
		Sleep mode <ul style="list-style-type: none"> ● The red and white lights flicker alternately: Display enters Sleep mode.
	Long press for more than 2 seconds	Power off

1.4 Remote Control



Buttons	Functions
	Turn on/off
	Mute or unmute
0~9	Number input
	Up/down/left/right button
	Channel BACK key
VOL+/VOL-	Control sound volume
PgUp/PgDn	Next/previous page in ops mode
	Active writing application
Input	Select different input source
Menu	Open/close menu
HOME	Back to Home page
Enter	Confirm

2. Installation

2.1. Safety Precautions

Installation Environment



Installation Direction

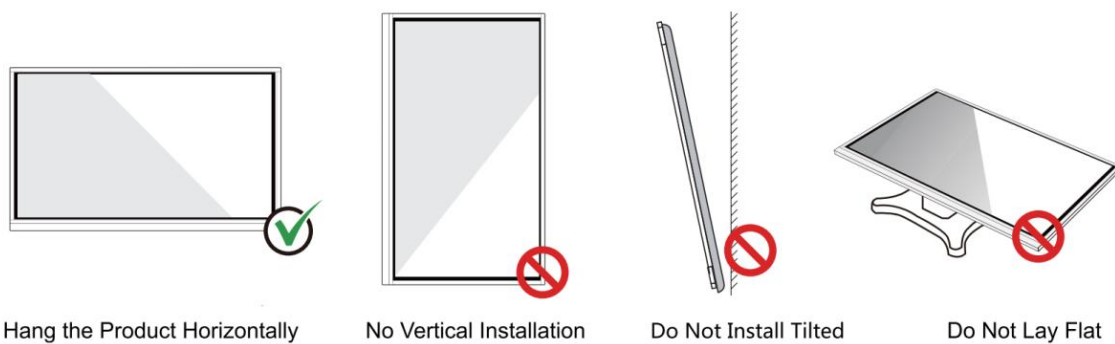

2.2. Installation Step

Step 1: Punching holes in the wall

Mark 8 holes location on the wall according to wall mounting bracket A and use the drill bit to drill the 8 holes. Depth of holes should not be less than 90mm (Ref. Picture 1)

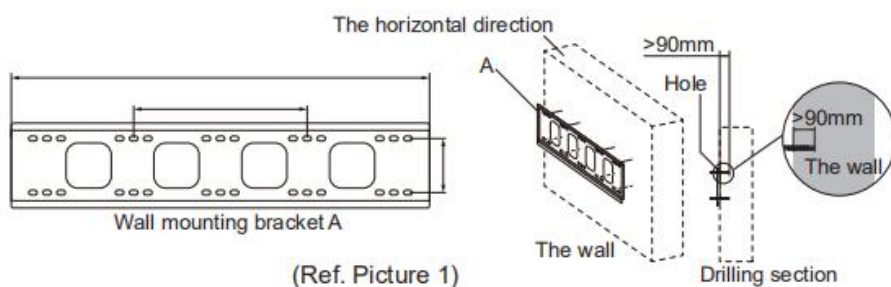

Step 2: Expansion bolt installation

Press the wall anchors into 8 holes. (Ref. Picture 2)

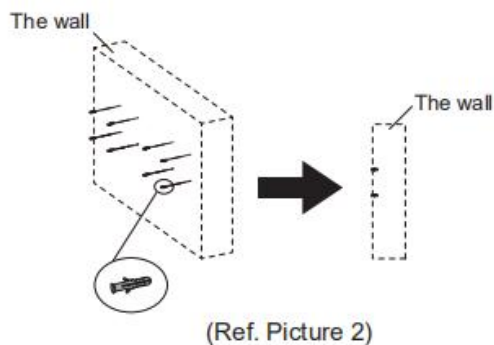

Step 3: Wall mounting bracket A installation

Install the wall mounting bracket A with 8pcs screws and gaskets. Please ensure that the wall mounting bracket A is installed horizontally. (Ref. Picture3)

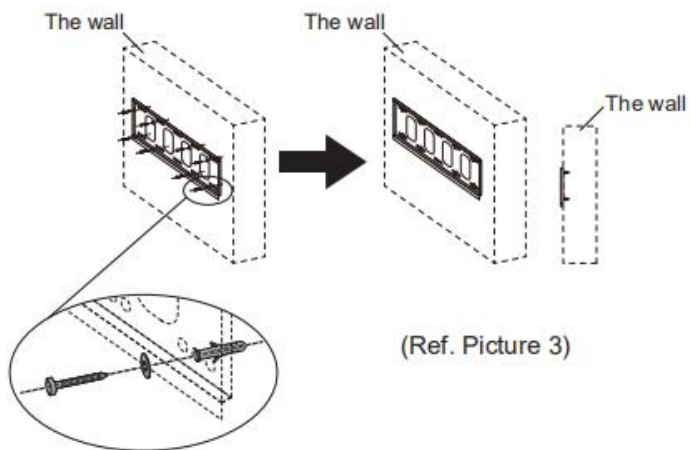

Step 4: Install the left& right hang bracket B to IQTouch.

Use screws to fix the hang bracket B at the back of IQTouch. Please check the direction of hang bracket B before installation. (Ref. Picture 4)

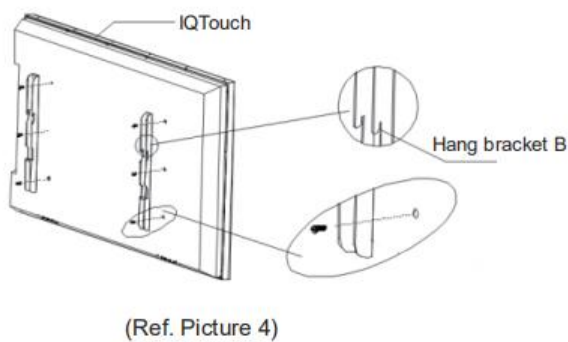

Step 5: Hang IQTouch on the wall mounting bracket A

Hanging the hang bracket B on the left and right onto the wall mounting bracket A, please ensure two hang brackets B completely hanged onto wall mounting bracket A, then tighten the screws of hang bracket B to prevent it slide. (See Ref. Picture5)

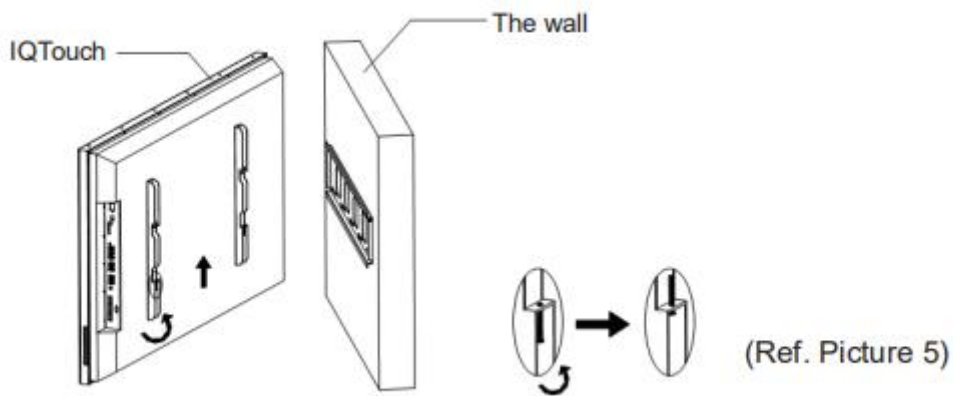

Note: The picture here is for your reference only .

2.3. Weight Loading

Net weight of the machine(65",75",86"): 40kg(± 1.5 kg), 56kg(± 1.5 kg), 66kg(± 1.5 kg).

- When using a mobile stand, ensure that the weight of the machine is less than the loading capacity of the mobile stand.
- When using the wall-mount bracket, ensure that the wall can support the weight of the machine. We recommend that the wall surface be reinforced and have a loading capacity 4 times of the weight of the machine. Consult a professional installer for wall-mount installation.

Note:

- The company does not undertake relevant legal responsibility for any problems caused by improper operation if the third-party mobile stand, or wall-mount bracket is beyond the scope of the machine.
- Do not install the machine where it might be hit by an opening or closing door.

Vertical Installation

When installing, try to keep the machine vertical. The vertical tilt range allowed for wall-mount installation is ± 3 degrees. An excessive tilt angle may cause the screen glass to fall off or the machine to collapse.

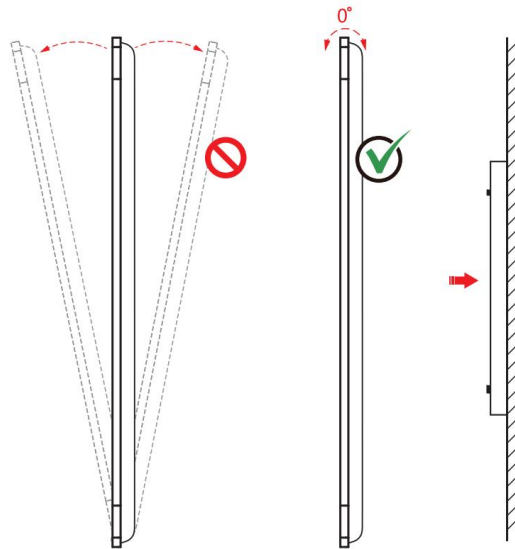

Note:

- In case of broken glass, all personnel must stand 3 meters away from the machine to ensure safety.
- Do not install or disassemble the machine if the glass is broken.
- For any problem, please contact our support desk. Returnstar is not responsible for any damage or losses incurred by users if the user fails to follow the instructions.

Ventilation

Ensure adequate ventilation and/or an air-conditioned environment. We recommend keeping certain distances from the side of the product to the wall or panels. Ventilation requirements are shown in following figure:

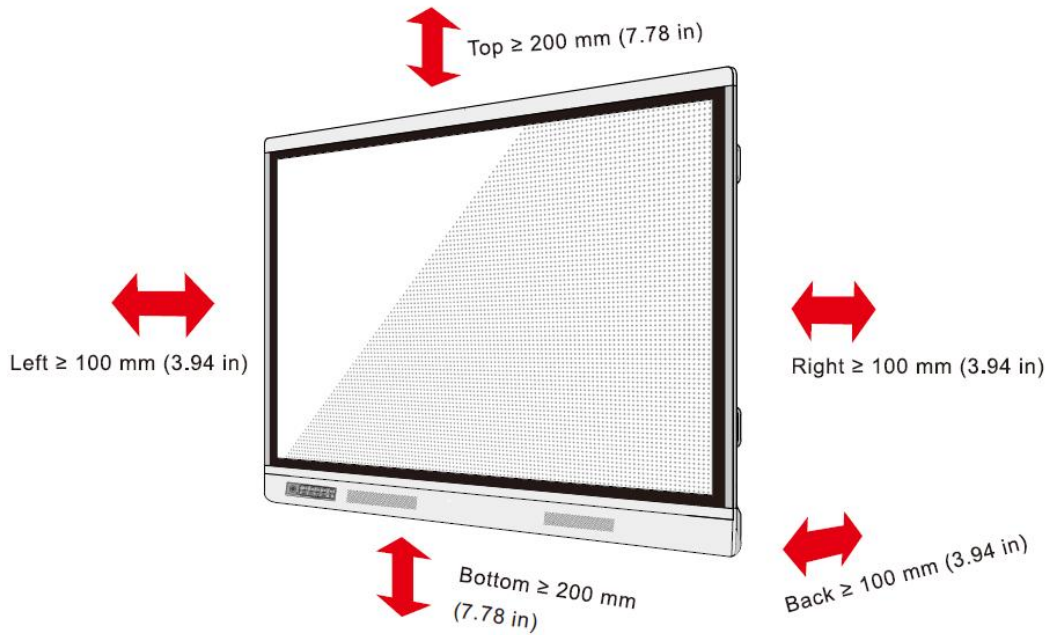

2.4. OPS Installation



The built-in computer does not support hot plugging. Therefore, you must insert or remove the built-in computer when the display is powered off. Otherwise, the display or built-in computer may be damaged.

Perform the following steps to install the built-in computer:

Step1

Unscrew the screws by hand to remove OPS shielding cover.

Note: This step is optional and applies to models with shielding cover.

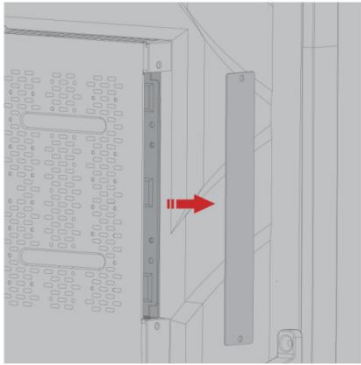

Step2

Push OPS into the port at the rear of the machine from right to left.

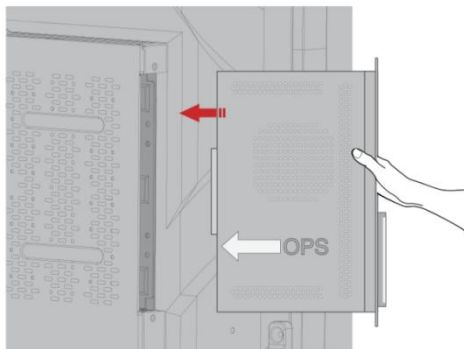

Step3

Secure OPS to the machine by using the screws.

Note: If the screen fuzzes, flashes or no signal is received from OPS channel after turning on the power, it means that OPS has not been properly installed. Please check it and re-install.

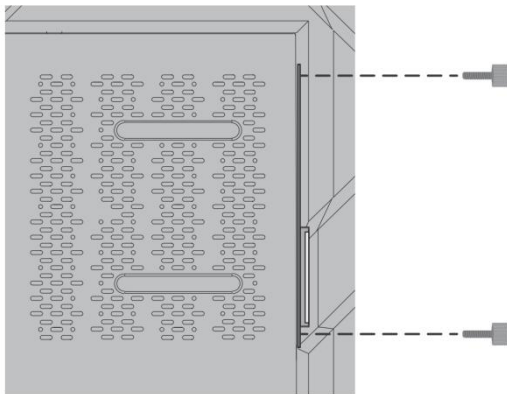

3. Getting Started

3.1. Power On

Step 1:

Ensure the power cable is fully seated into the panel and wall outlet before powering on the panel. Please confirm your wall outlet supports a power range of 100V to 240V with frequency at 50 Hz/60 Hz \pm 5% and is fully grounded.

NOTE



The power outlet should be installed near the equipment and should be easily accessible.

Step 2:

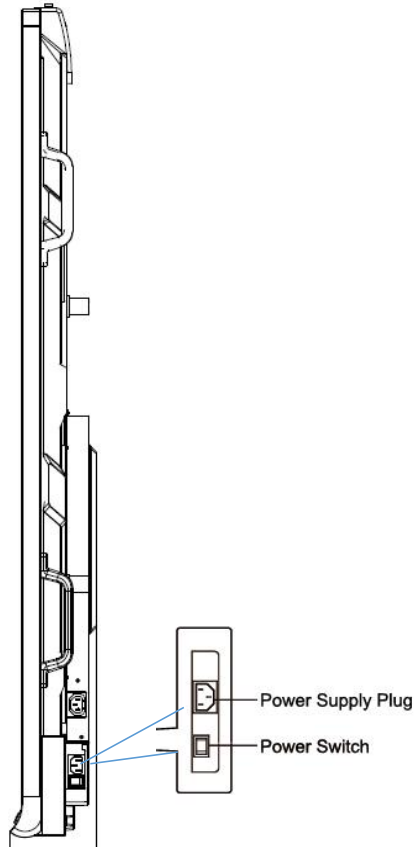

Flip the power switch located on the side of the product to “I”.





Step 3:

Press the power button  on the front control panel or  on the remote control.

3.2. Power Off

Step 1: Press the power button  on the front panel or the power button  on the remote control to enter sleep mode.

Step 2: Long press the power button  on the front panel or the power button  on the remote control, The **Warning** dialog box will be displayed as shown in the following figure.

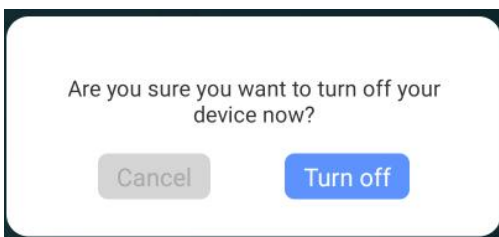

Step 3: In the **Warning** dialog box, tap **Cancel** to return to working mode. Tap **Turn off** to turn off

the panel, and the power indicator will turn red.

Step 4: If you want to completely turn off the product, turn off the rocker switch behind the panel (next to the power socket) and unplug the power cord.

 **NOTE**

If an OPS is installed, the OPS and the screen will be simultaneously powered off when the power is turned off.

- Please properly shut down the panel before disconnecting the power source or it may cause damage. Accidental power failure may cause damage to the panel.
- Do not repeatedly turn the power on & off in a short period as it may cause malfunction.

4. IQ OS

4.1. Homepage

4.1.1. Start Guide

The startup guide is the page that appears the first time the user turns on the device, guiding the user to quickly become familiar with the basic functions of IQTouch. It mainly includes language selection page, network setup page, time setting page, and device name page.

4.1.1.1. Launcher

The launcher is the landing page that users see after starting the device, which is the main page of the IQTouch. The system defaults to the IQ OS theme, as shown in the following image:



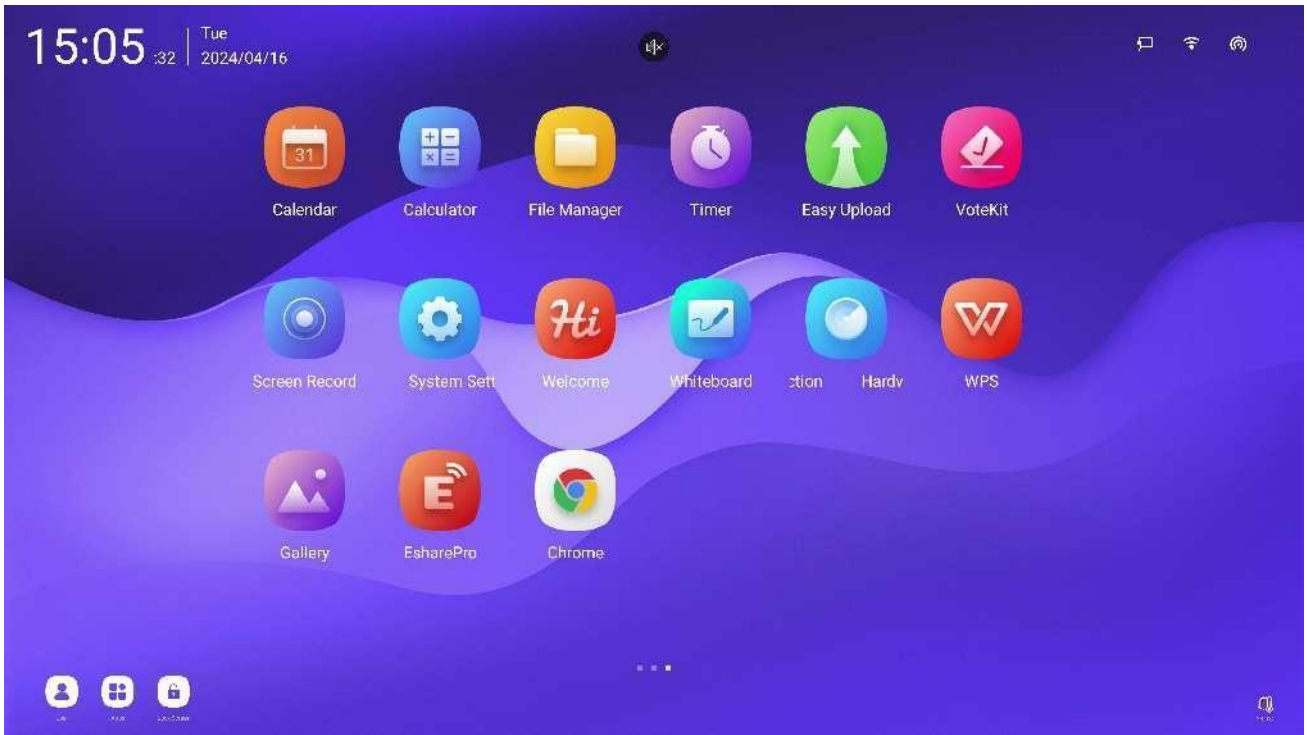

4.1.2. Introduction of Page Elements

4.1.2.1. Wallpaper

Display the unique wallpaper of IQ OS 5.0.

4.1.2.2. Time

Long press to open the system settings. You can set date, time and formats manually.

4.1.2.3. Small components

Supports displaying channel preview, scan to occupy the screen, or note show in System Settings > General > Custom > Small Components.

- **Note show**

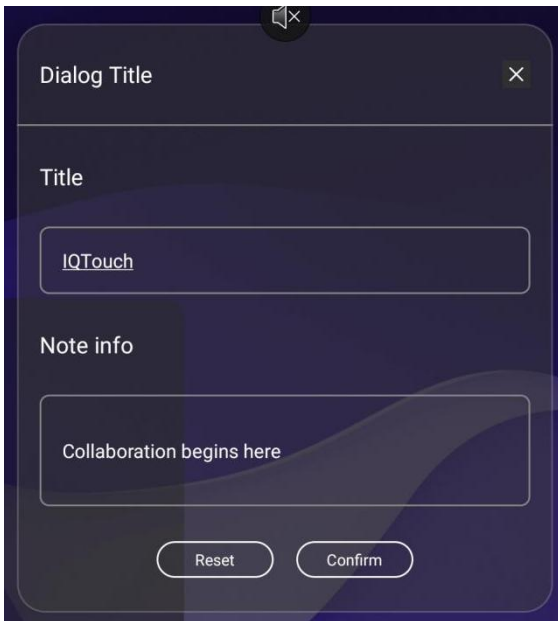

Long press the launcher title to pop-up editing window.

The content of the small component will be retained after the system restarts, and the initial content can be displayed through the Reset Button on the launcher editing page.

- **Channel preview**

In Channel Preview mode, you can preview the content of channels.

- **Scan to occupy the screen**

In Scan to Order the Screen mode, you can share the content of this area by scanning a QR code.

4.1.2.4. Application icon

Click to enter the application.

4.1.3. Status Bar

The top status bar displays network status, and the bottom status bar displays user switch, APPs, and lock screen, which are introduced as follows:

- **Network Status:** Displays your current connected network and network status.
- **User Switch:** This function is an icon displayed when multiple users are enabled. Click to access the user selection page. Users can make relevant settings in Settings -> System -> Multi-User.

- **APPS:** This function serves as the entry icon to the APPS page. Click to access the APPS page.
- **Lock Screen:** This function is the icon for locking the screen. Click to access the lock screen page. Users can make relevant settings in Settings -> System -> System Security.

4.1.4.Sidebar

The sidebar is a set of frequently used applications that are constantly displayed on the screen. It allows you to perform various operations quickly.

Activation Method: Slide from the left or right edge towards the center to summon it, or click the expansion buttons on the left or right to expand the sidebar. If no interaction occurs with the sidebar for 10 seconds, it will automatically retract.



The sidebar functions include: Back, Home, Multitasking, Annotation, Control Panel, and Signal Sources.

- **Back**

Click it once to return to the previous step of the operation until back to the home page or the starting position of the operation.

- **Home**

No matter which page you are currently on, click on the home page icon and quickly return to the Android home page. The current application goes back to the background that users can retrieve in multitasking.

- **Multi-task**

Go to the system multitasking page to view and manage the running applications in the background.

- **Annotation**

Enter the annotation mode, please refer to the "annotation function".

Click the Annotation icon on the sidebar or compass to enter the annotation mode, you can write annotations on the current interface.

- **Control Panel**

Click the Control Panel icon to expand the Control Panel on the current page. The Control Panel is divided into three parts: Quick Tools, Sound and Brightness Adjustment, and the Application List.

- **Signal Sources**

Click the Sources icon to display the list of signal sources (connected sources are highlighted). Click to access the respective channels.

4.1.5. Compass

The compass is a shortcut for the users, and the basic operation is as follows:

- Long press the interface with five fingers to call the compass.
- Click on the center circle of the compass to expand or retract the compass.
- Drag the circle in the center of the compass to move the compass to a different position.

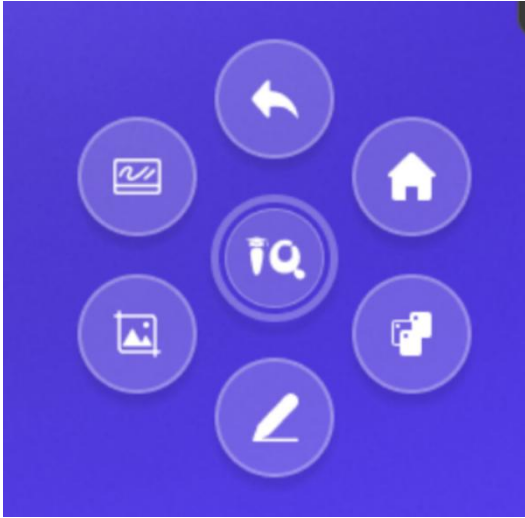

The Compass consists of 6 functional modules, among which the Back, Home, Multitask are the default functions, and the others can be customized, you can set up common functions depend on your preference, the specific operations: System Setting > General > Compass.

4.1.6. Recent page

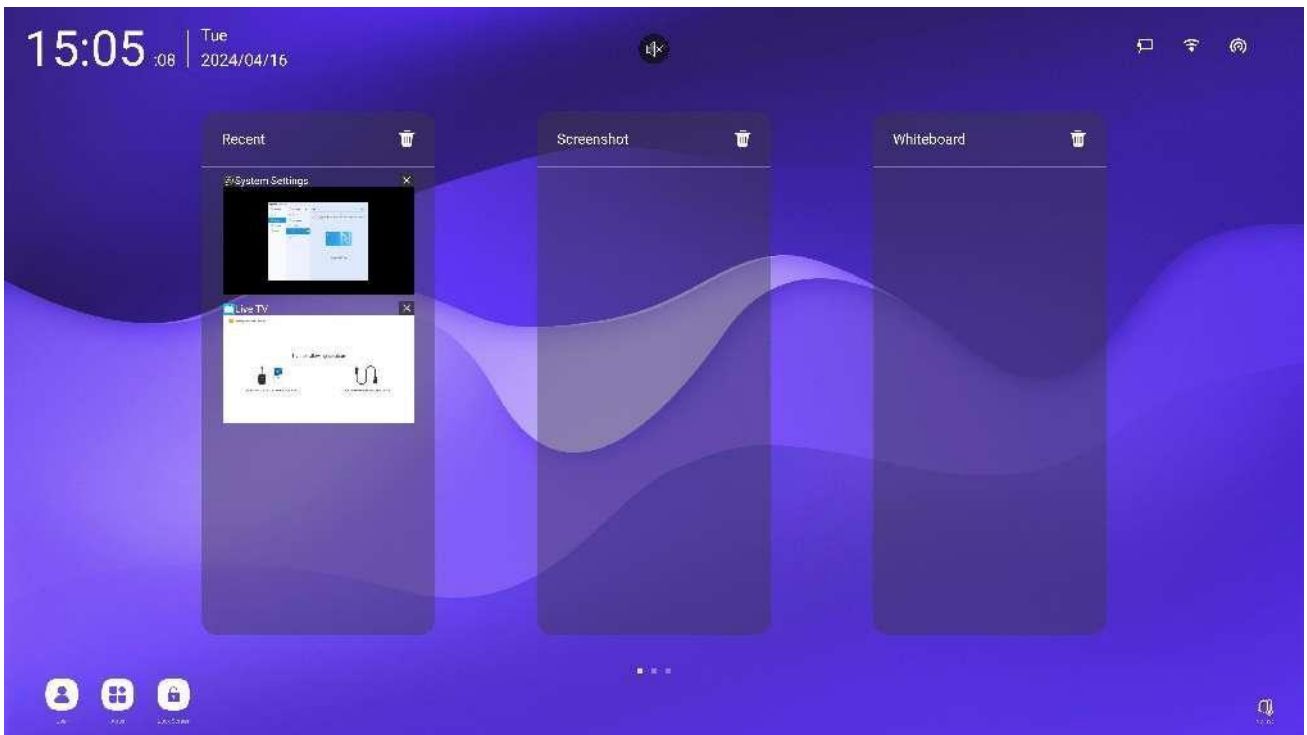

● Recent

Recent tasks are listed at the top.

Task previews are displayed, click to enter a task.

Click the delete button next to a task to exit it.

Click the delete icon on the top right to exit all tasks.

● **Screenshot**

Recent tasks are listed at the top.

Recent screenshots are displayed with a maximum of 10 previews.

Click to open a screenshot, scroll up and down to view more if exceeded.

The "More" file icon is located at the bottom of the recent screenshot preview list.

Click "More" to switch to the location of the screenshot source files.

● **Whiteboard**

Whiteboard content saved in editable format appears under "Recent Whiteboards," using the first page as a preview.

Click on the preview to open and enter the whiteboard.

Maximum of 10 preview images are displayed.

The "More" button is located at the bottom of the preview list.

Click "More" to switch to the location of the whiteboard source files.

Scroll up and down to view more if exceeded.

4.2. Whiteboard

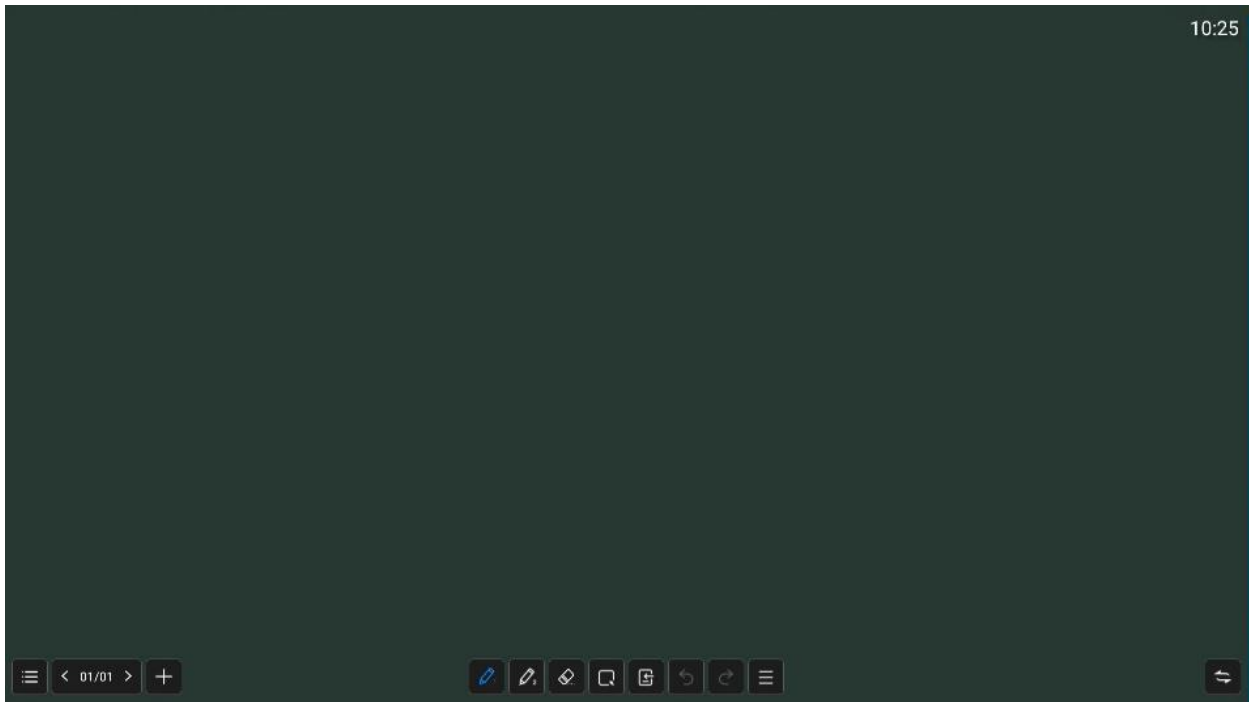

4.2.1. Menu

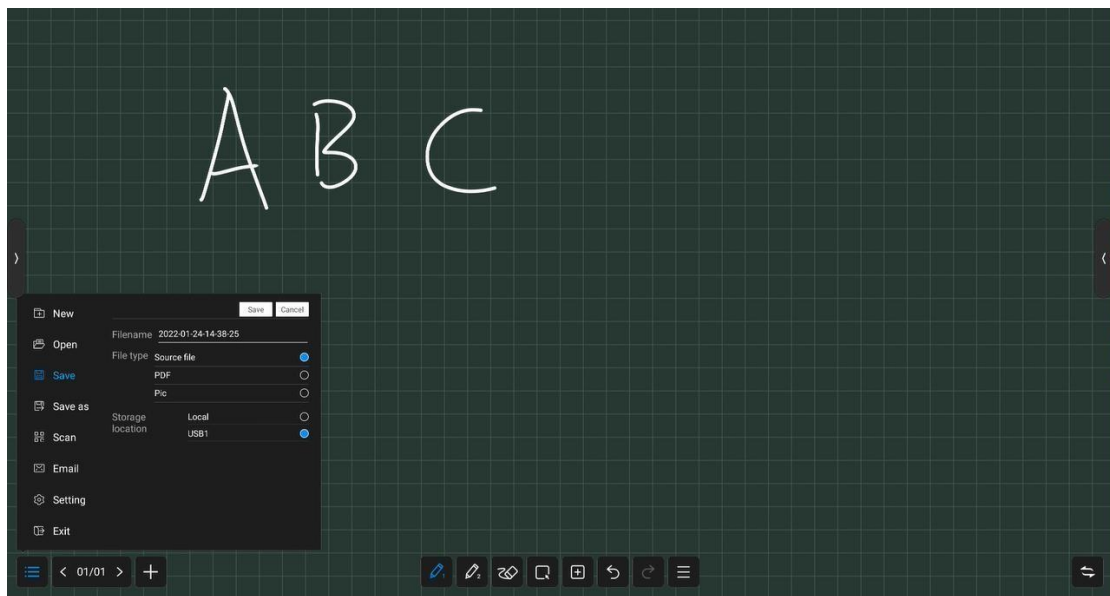

The menu contains New, Storage, Sharing, Close, and Setting up; basic operations are as follows:

- **New:** Click on “New” to create a new whiteboard, then the current document is closed; there will be a prompt if the current document is not saved.

- **Open:** Enter the File Manager can see all the whiteboard files, click to open the file; there will be a prompt if the current document is not saved.
- **Save:** Click on "Save" to save the current document, you can customize file name, select storage path and file save format.
- **Save as:** Save the current whiteboard file as another whiteboard file, you can customize file name, select storage path and file save format.
- **Scan:** Click on "Scan" in the Menu panel to show the QR code page, user can download pictures and files by scanning QR code; password settings are optional; support local LAN and external network sharing, users can choose the default mode in the system settings; click on "Encrypt" above the QR code to generate a digit-password, users need to enter the password to get the content.
- **Email:** Send contents on the current whiteboard by email to a specified user, you need to preset the sender mailbox.
- **Exit:** Click on "Exit" to exit the whiteboard and close the page and process; the user is prompted to save the file if the current document is not saved.

4.2.2. Setting

Set the basic state of the whiteboard to make the presentation style and interaction more matching with user expectations;

- **Multi-finger writing:** Click to switch on/off; when turned on, open multi-finger writing mode, can write by 20 people at the same time, when turned off, open single writing mode.
- **Paintbrush style preset:** Set the default paintbrush style when entering the whiteboard, set the color, thickness, transparency, and paintbrush style.
- **Background setting:** Set the default background style when entering the whiteboard, you can select the background color and gridline style.
- **Email settings:** Set up the sender mailbox, which is the sender mailbox when sending a whiteboard file.

4.2.3. Page Management

Page management is mainly to manage the pages of each whiteboard, including:

- **Page up:** Click to switch to the previous page of the current page, not clickable on the first page.
- **Page down:** Click to switch to the next page of the current page, not clickable on the last page.
- **Current page:** When is shown as 5/8, the preceding number “5” indicates the current page, and the following number “8” indicates the total number of pages; click to view all page thumbnails; you can delete pages or move the page order on the thumbnail.
- **New page:** Click to insert a new page after the current page, and jump to the new page.

4.2.4. Paintbrush

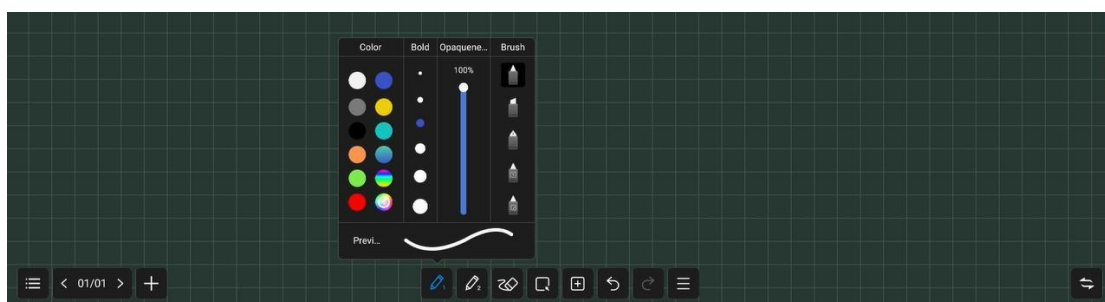

- **Paintbrush 1 and 2:** There are two paintbrush: paintbrush 1 and 2, click one to use, click again can change the brush style.
- **Color:** Preset 9 single colors and 2 gradually changing colors, click to select and affected; brush color can also be customized by the user, click and choose your favorite color.
- **Thickness:** Preset 6 brush sizes, click to select and affected.
- **Transparency:** Paintbrush transparency can be adjusted between 6%-100%.
- **Paintbrush style:** There are three kinds of paintbrush styles, normal brush, marker pen and pen, also has two intelligent brushes with function of character recognition and pattern

recognition, select it then you can convert your handwriting into printed text and pattern.

4.2.5. Erase

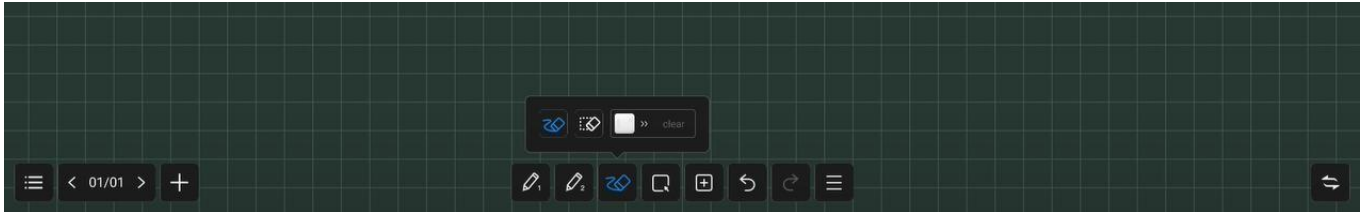

You can erase your handwriting directly with the palm or back of your hand while writing, the following modes are also supported:

- **Circle Eraser:** Handwriting in the closed circle can be cleared with just a touch.
- **Circle to delete:** Cross the brush with the object to delete. Strokes that cross or fall within the final circle will be deleted.
- **Slip Clean screen:** Swipe "Clear Screen" to clear all the handwriting on the current page.

4.2.6. Select

Click on "Select" to switch to the Select mode. Click on the handwriting, picture or other elements on the screen to select it, and draw a free closed shape to select the elements within it. The selected element can be dragged, and moved, with the multi-finger zoom operation.

Click the selected element.

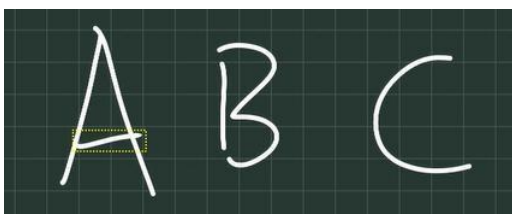

Select the element through which the shape passes.

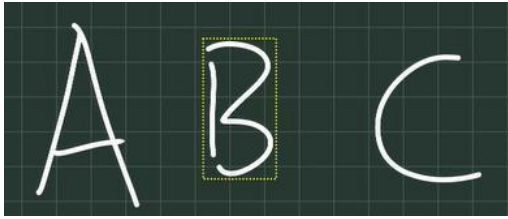

Select the element within a closed shape.

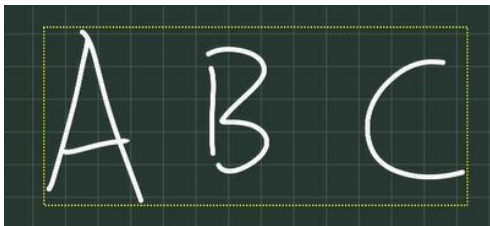

4.2.7. Insert



Inserting function supports inserting multiple elements and contents into the whiteboard, including:

- **Picture:** Enter the file manager-picture page, click the picture to insert; you can select (up to 10) pictures then insert them into the whiteboard.
- **Table:** Click the table icon, select number of the table rows and columns, click OK to insert the table into Whiteborad. Use the brush to enter content in the table, table width and height automatically adapt to the brush size; use the selection tool to select the table and add or delete rows and columns, can also use the brush tool to draw the horizontal or vertical line in the same row or column through the table to add row or column, similarly, use the brush tool to draw "Z" lines in the same row or column through the table to delete rows or columns.

- **Shape:** Click and select the shape that you want to draw, and then drag the brush to the whiteboard to draw the shape.
- **Mind map:** Click the mind map to insert the subject into the middle of the whiteboard automatically; use the selection tool or double-finger click to select and edit the subject.
- **Document:** Click the document insert, then enter the File manager-Document page, you can choose PPT, word, or PDF file to insert, in WPS free window mode.
- **Video:** Click the document insert, then enter the File Manager-Video page, choose video to insert, in media player free window mode.
- **Signal source:** Click to select the signal source that is supported by the device, and the unaccessible sources are in gray and uninsertable.

4.2.8. Undo and Redo

Undo: Click the Undo button to cancel the most recent step, and support up to 20 steps.

Redo: Click the Redo button to resume the previous undo operation.

4.2.9. More

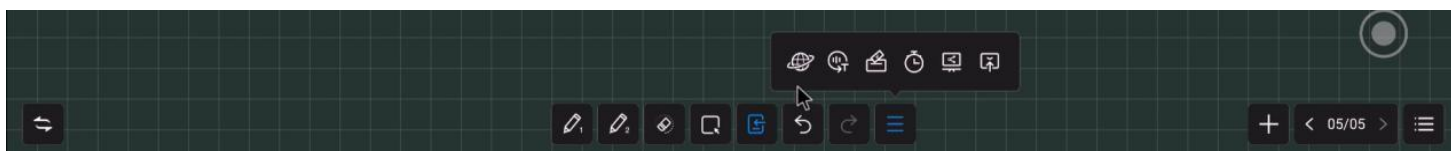



The More function provides multiple apps' invocation, including:

- **Browser inserts picture:** Click to open Google, enter the keywords then click, long press the picture which you want to add from the search results page, then insert to the whiteboard.
- **Vote:** Used for voting in meetings.
- **Timer:** Used for timing in meetings.
- **Quick Transfer:** Transfer file from mobile to the screen, and insert on the whiteboard.

4.3. Screen Sharing

The main function of this application is to wirelessly transmit the content of mobile phones, tablets or computers to the display, and truly achieve the wireless screen transmission function of the projection device and the projected device (note: mobile phones, tablets or computers need to be on the same local area network).

4.3.1. Operating instructions

1. Click  or  icon to open the multi-screen interaction interface, and the application display interface is as shown.

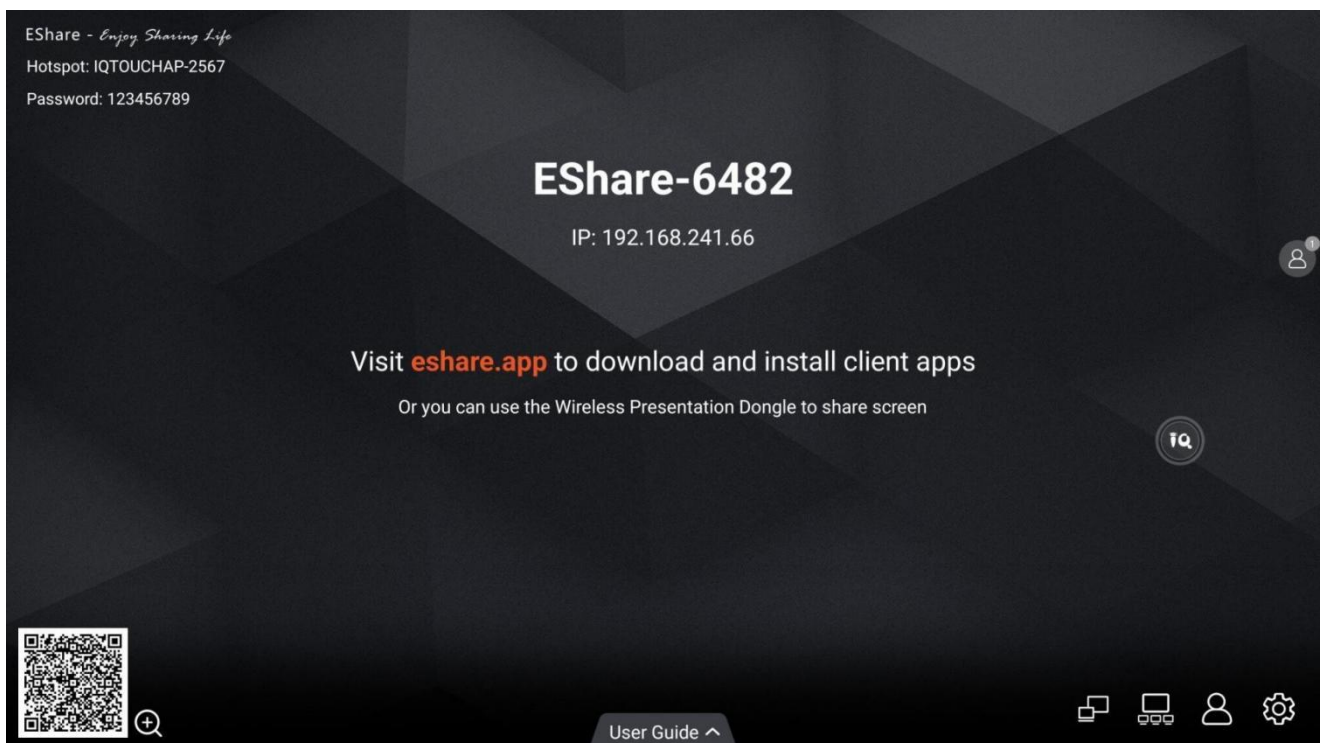

2. Function activation

Activate it only through connecting network if you have purchased EShare serial number.

3. Operating description

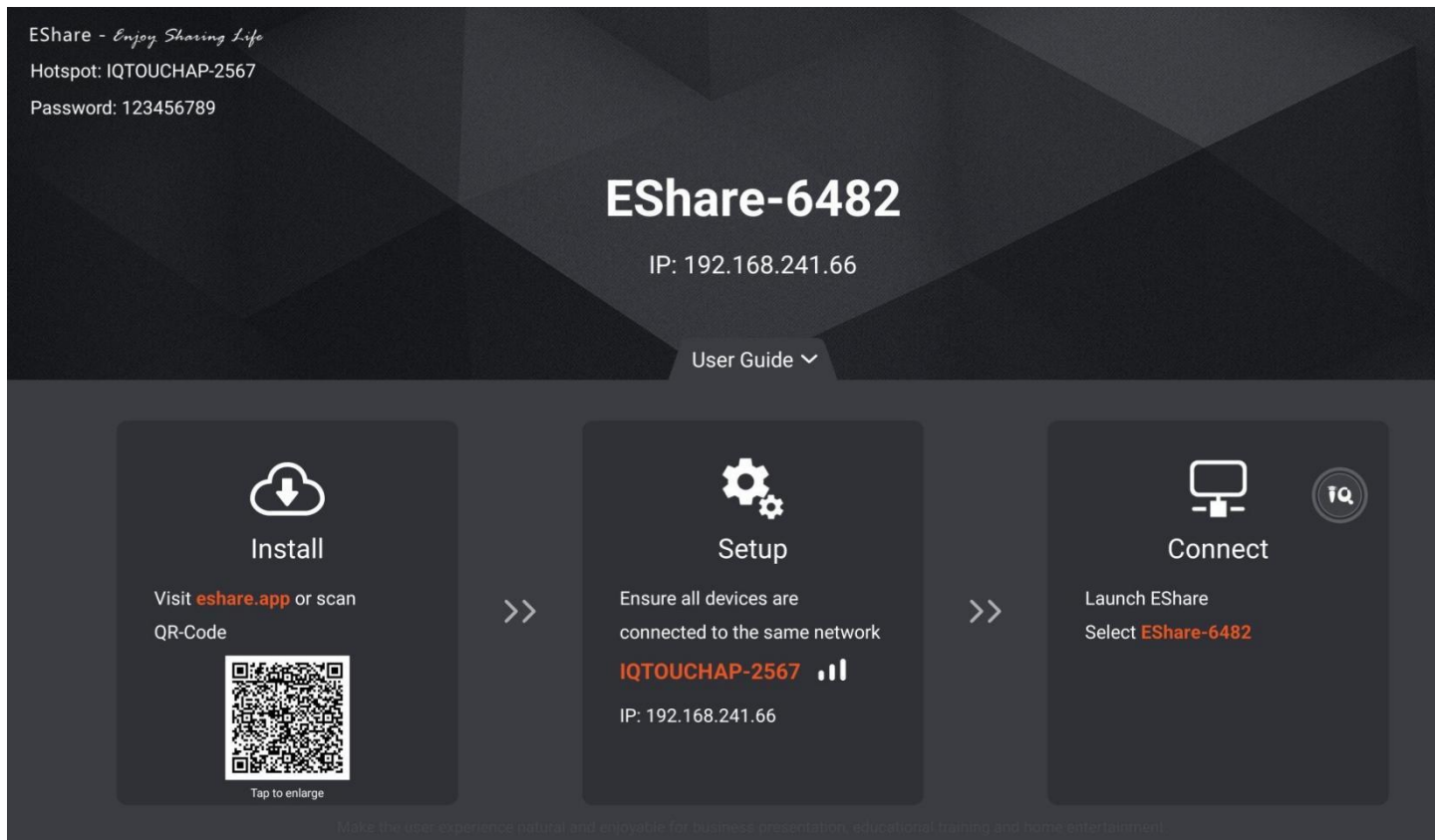

- 1) Android mobile phone connection network, scan the multi-screen interactive interface QR code to download and install E-share application software (Apple mobile phone does not need to download);
- 2) The mobile phone needs to use the same network as IQTouch. The Android mobile phone can open the E-share to cast the screen, and the Apple mobile phone can open the AirPlay to cast the screen.

4.3.2. Special instructions for multi-screen interaction interface

Device name

Click  icon, user can modify the device name

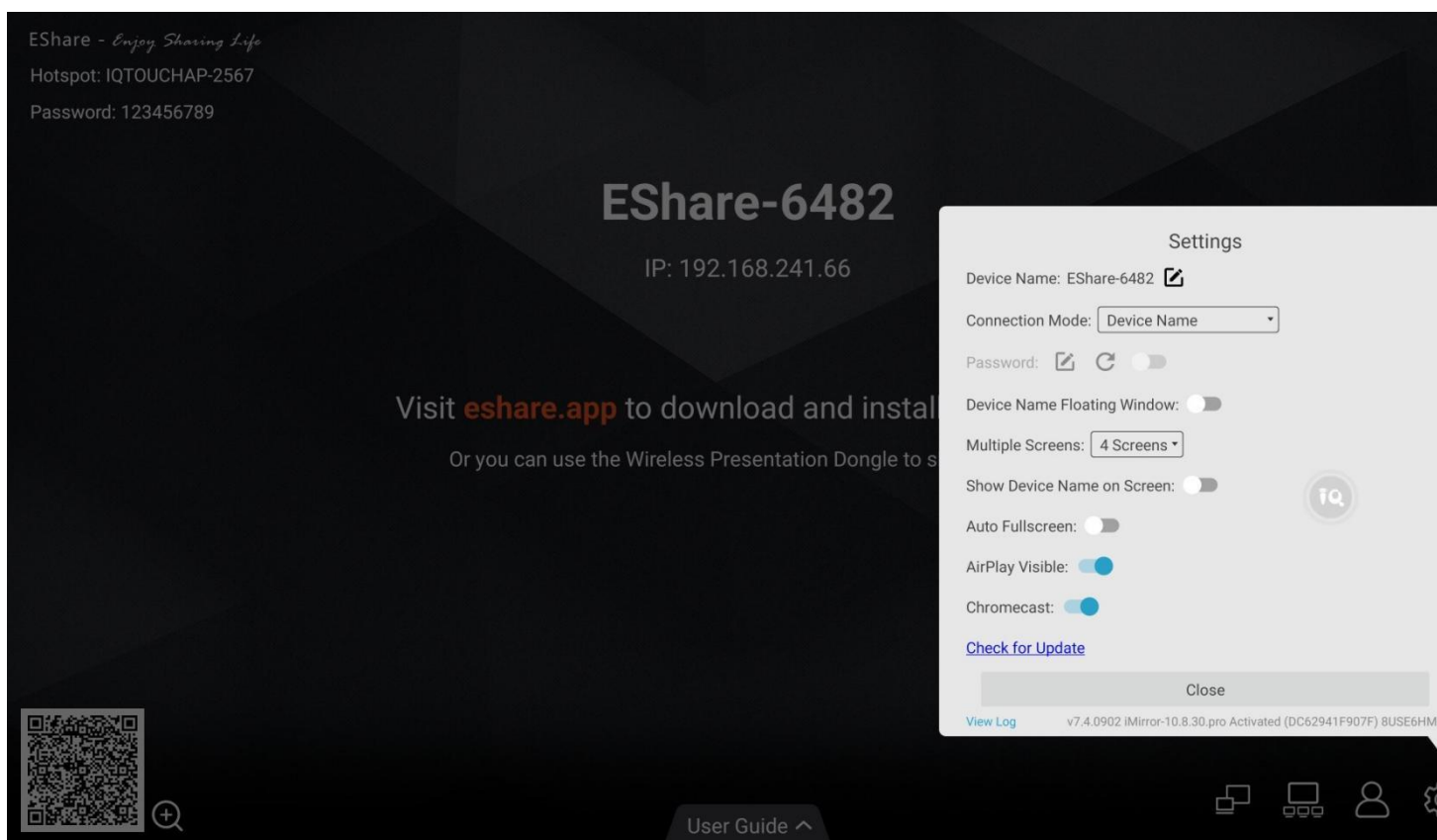

In this interface, you can modify the device name and set the connection password. when an Android phone connects to touch screen, it needs to enter the connection password to connect to the screen.

Multi-split screen: set the number of split screens

Show Device Name on Screen: the device name is displayed on the screen when it is turned on

Airplay visible: Airplay is visible when it is turned on.

Miracast visible: Miracast is visible when it is turned on.

4.3.3. Webcast remote screen sharing

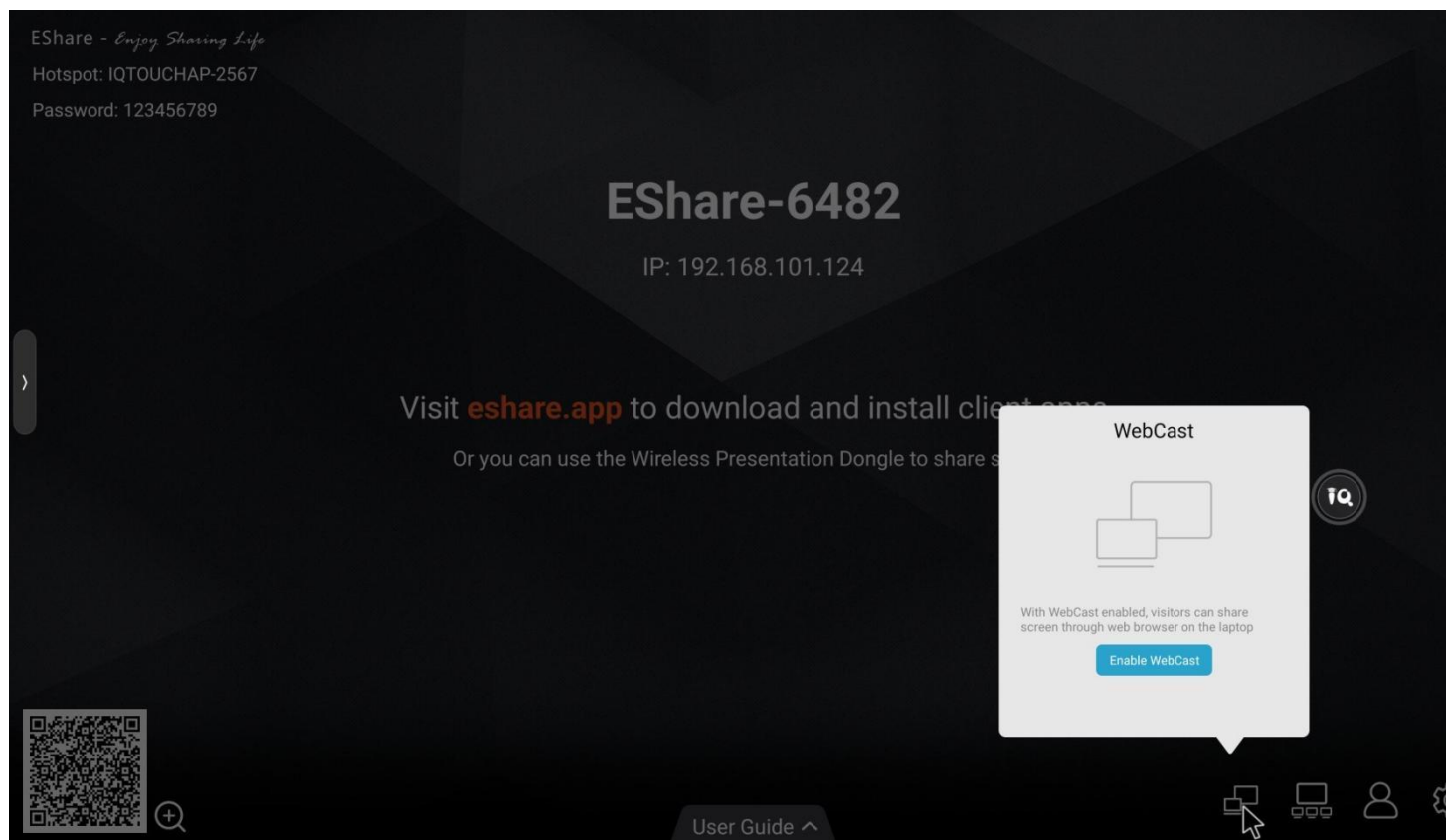

- Click Enable Webcast to obtain the IP address for visitor on the center place of the current page. Open browser and input the IP address to share your personal screen from different places with no requirement of the same LAN.
- Click Disable Webcast to exit remote screen share.

4.3.4. Laptop screen sharing

The screen sharing of the laptop needs to be used with the IQShare button. The IQShare button is as

shown below:



Note: Before using the IQShare button wireless screen function, user needs to make sure that the hotspot of the Touch screen is turned on.

Please refer to the User Manual of IQShare button for more instructions.

4.4. Mini Whiteboard

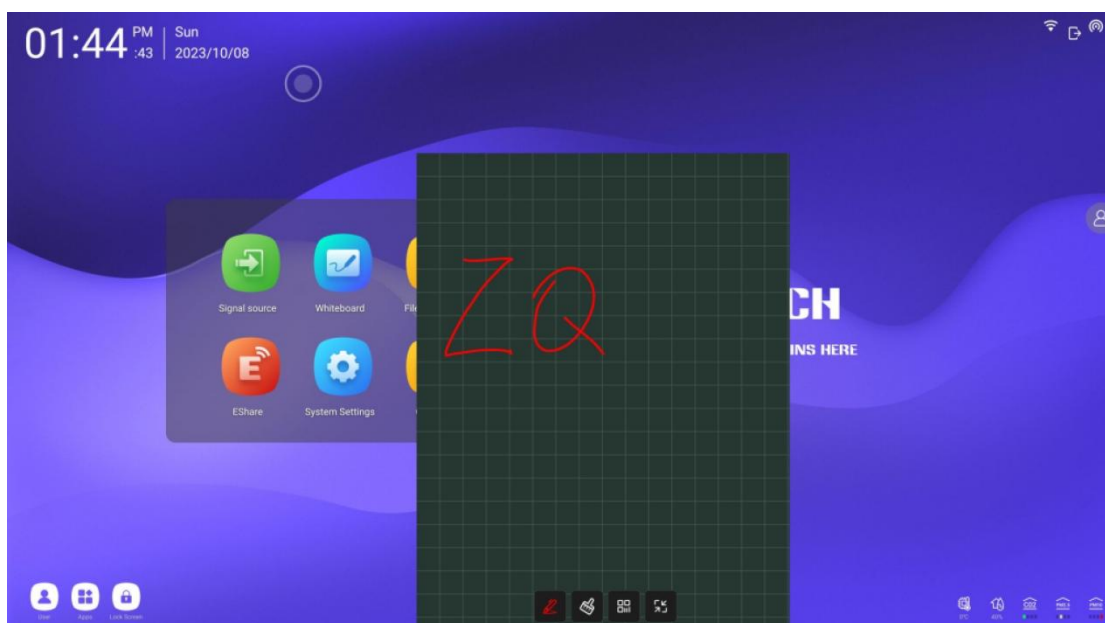

Swiping up from the bottom of any page, can quickly slide out the mini whiteboard and write quickly;

basic features include:

- Paint Brush: You can choose the color and write fast.
- Erase: Same as whiteboard erase, see 3.1.5 Erase.
- QR code: Click scan code to generate web link QR code, you can use mobile scanning QR

code to obtain whiteboard content (picture format). You can open encryption, scan code after entering the generated password to obtain content.

- Minimization: Click or multi-fingers slide down to fold up whiteboard.

4.5. Annotation

Click on the annotation icon in the sidebar or compass to enter annotation mode. You can write annotations on the screen.

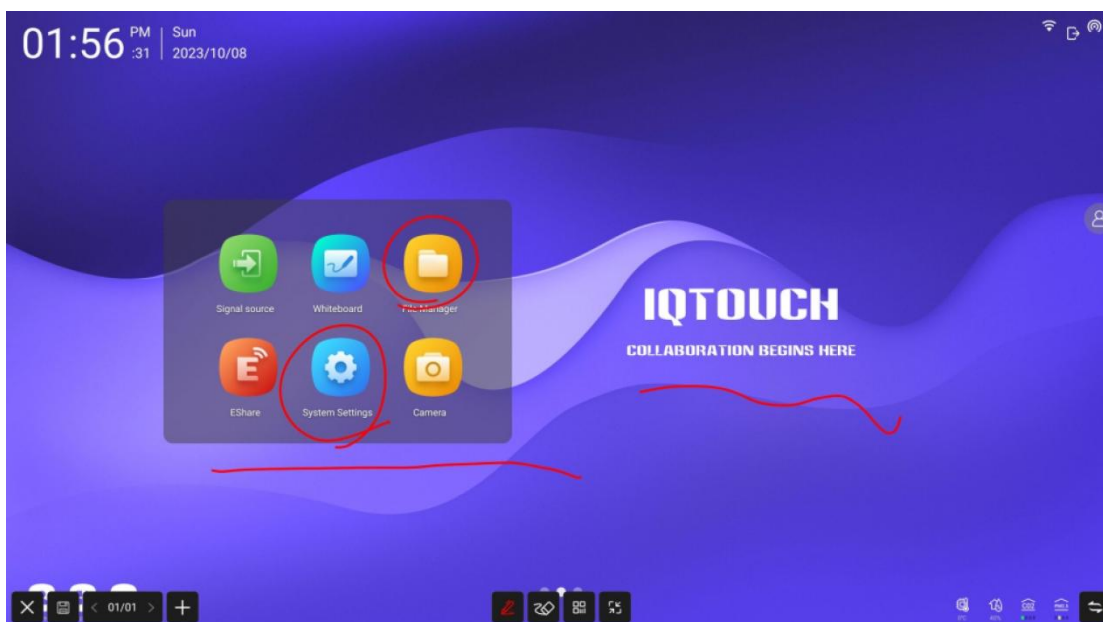

4.5.1. Writing

The default pen color is red. Click the writing icon to set the pen color, opacity, and thickness.

4.5.2. Erase

Erase in the same way as in classic whiteboard mode.

4.5.3. Minimization

If you need to switch pages or perform actions on the current page, click 'Minimize' to temporarily exit annotation mode. You can re-enter annotation mode through the sidebar or compass.

You can view your previous annotations in page management. On the left of screen, click >  to check your previous annotations on different pages.



4.5.4. Close&Save

Click the close button in the bottom left/right corner to exit the annotation mode and clear all annotation content. Before exiting, you can choose whether to save all content, with the option to save it as an image or PDF file.



4.6. Applications

4.6.1. File Manager

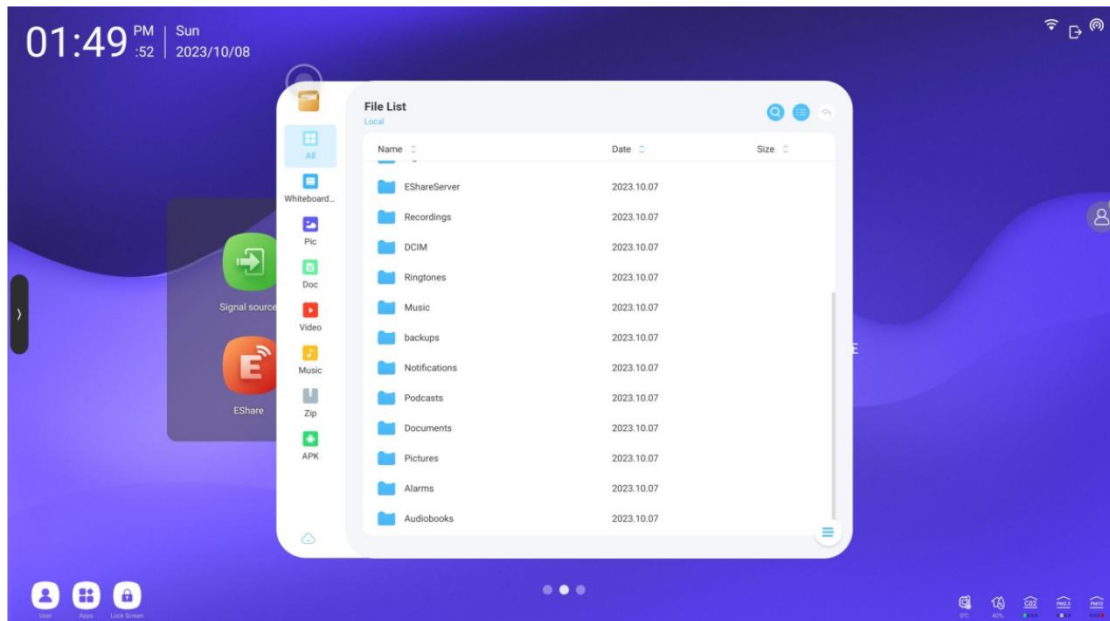



Introduction

File manager can view files within local and external devices of the system, providing two forms of viewing:

- All documents: Open in the folder directory.
- File type: Search files in the local and U disks by file type, such as whiteboard files, pictures, videos, music, compression packs, etc.

Common function

- Opening file: Find the file that you want to open then click.
- Selecting file: Click  on the bottom-left corner of the file list page, select the file, replication, cutting, delete, and other operations are supported.
- New folder: Click  on the bottom-left corner of the file list page to new a folder.
- Form: Click on the two icons  in the lower right corner to switch between tile and list.
- Order: Click on the top of the file list to organize by file name, file size and file time.

4.6.2. Multi-window

Multi-window is to facilitate users to operate the functions of different applications at the same time and display different contents at the same time. The basic operations are as follows:

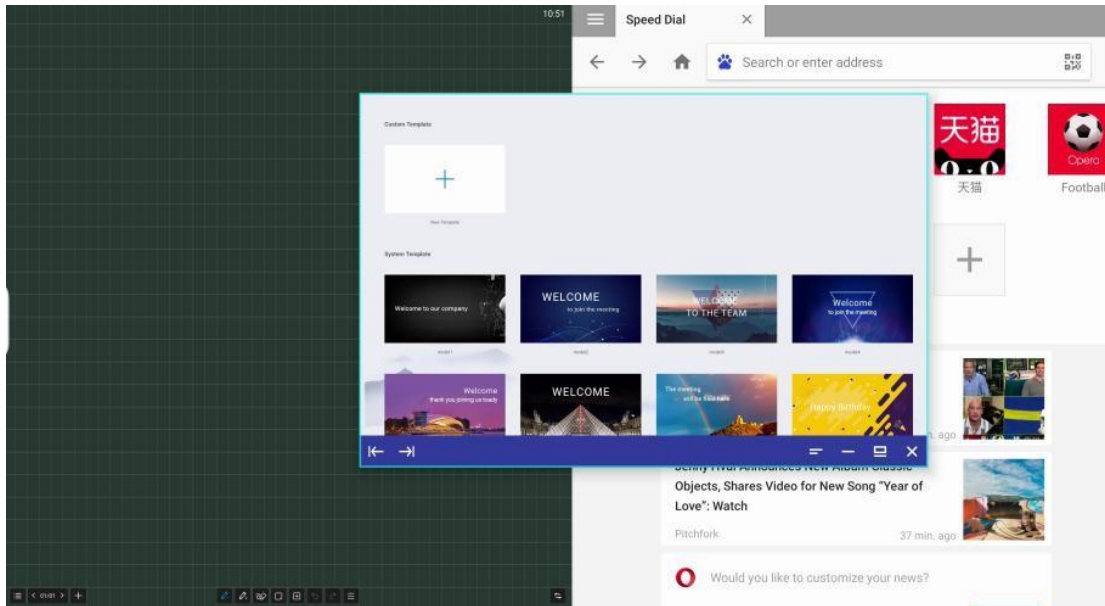







Opening Multi-Window

Users can open multiple windows in two ways:

- On the menu screen, long press an app icon to pop up a management window, opting for a 'free window' to open your app.
- In the sidebar app management, users can directly access apps in free window mode by long pressing and clicking on them.
- When using the app, five fingers snap together in the middle of the screen, and users can quickly enter the free window mode.

Multi-Window Operation

- After opening multi- windows, you can click the corresponding window to select it at the bottom of the apps, and perform the following operations on it;
- Dragging: You can move a free window by pressing and holding the control bar at the bottom of the screen;
- Scaling: Select, press on the edge of the free window and drag to scale the width and height of the window, and click on the corner to scale the width and height at the same time.
- Left and right edge scaling: Tap the scale button   on the left side of the control bar to scale an app by the left/right side of the screen. Operating two applications at the same time can achieve a left and right split screen.
- Restoring the original size: Click the Restore icon  on the right side of the control bar to restore the window to its original size.
- Minimization: Click the Minimize icon  on the right of the control bar to fold up the app, which can be found in multitasking.
- Maximization: Click the Maximization icon  on the right of the control bar to apply a full-screen display.
- Close: Click the close icon  on the right of the control bar to close the current application.

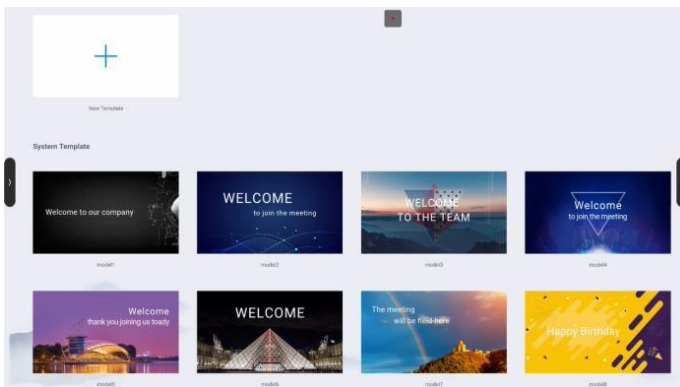
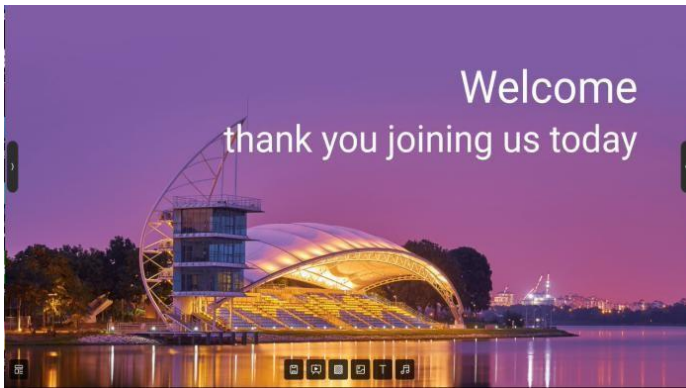

4.6.3. Welcome page





Multiple templates are built into the welcome page. You can click to enter. Users can modify and save the template as a new one. After entering the template page, users can modify the background, text, music, etc., after the setting, click the button 'play' to display.

4.6.4. Screen recording



- 1) Click the application icon to enter the application, and the application will open in a small window.
- 2) Click  , you can start recording, start timing and recording screen; click  again can pause timing and screen recording.
- 3) Click  to end screen recording, and the saving option pops up.



4) Click  to minimize the application, fold up the screen recording function and display it as a square dot.

5) Click  to close the screen recording. If the screen recording is in progress, it will prompt you to save.

4.6.5. Screenshot



Screenshot can quickly capture and save the screen content.

- Click on screenshot icon on sidebar or compass to take a screenshot.
- Drag the screenshot circle to move the screenshot position.
- Drag cross point to change the length and width of screen area.
- Click  in the right corner to open the whiteboard and place the screenshot into the whiteboard.
- Click  in the right corner for a full-screen screenshot.
- Click  in the right corner to close the screenshot function.

- Click  in the right corner to confirm the screenshot and prompt to save.

4.6.6. Gallery

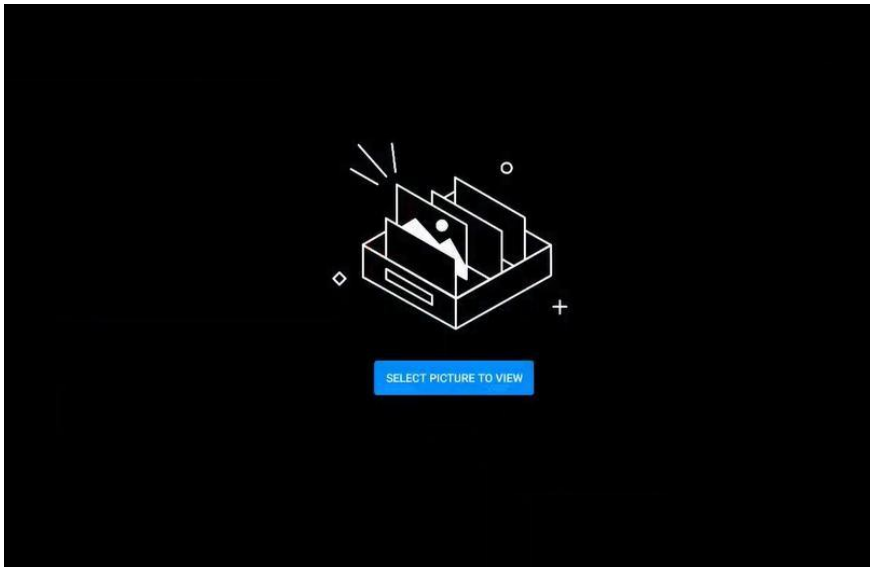

- 1) Click the application icon to enter the app; or select the picture in the folder to open, enter the application.
- 2) App renders image preview and navigation.
- 3) Slide left and right to turn pages for display.
- 4) Click the control bar at the lower left corner, you can do the previous page, next page, flip, rotation and other operations on the picture.

4.6.7. Voting System

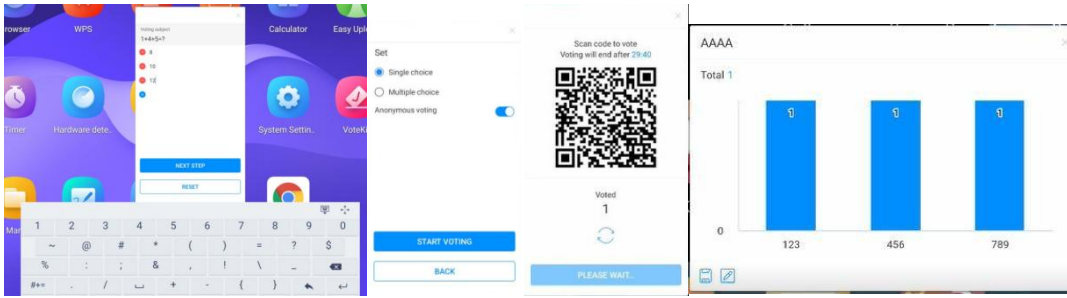

Note: The voting device can be used only with network support. If there is no network, this function is unavailable.

- Click the app icon to enter the app.
- Display the voting theme and option setting page, click the input box to invoke the keyboard input.
- Click "Reset" to clear options and themes; Click 'Next' to set single/multiple, anonymous/real name requirements.
- Click "Start voting" to present the QR code for voting. Participants can scan the code to vote and the voting results will be updated in real time.
- Click "End voting", the voting ends, the QR code loses efficacy, the voting page is closed; Present the poll results.
- Click 'Save' to save the voting result; Click "Place whiteboard" to insert the voting results into the whiteboard display.

4.6.8. Easy Upload

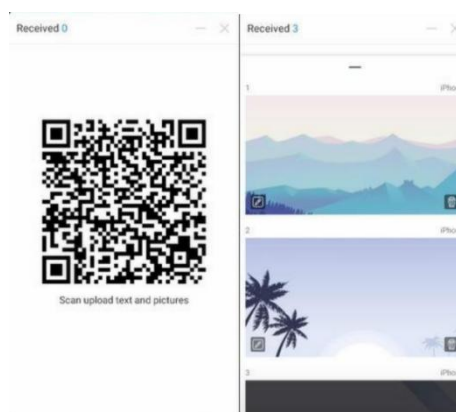

Easy Upload is an application that can quickly upload pictures and text from mobile phones to the IFPD for sharing and display. The basic operation process is as follows:

- Click the application icon to enter the app.
- Scan the QR code on the screen with your mobile phone to enter the page for easy file uploading.
- Select the local picture or input the text content on the mobile terminal and click Add to enter the uploading and sending process.
- After uploading successfully, the machine will display the recently uploaded picture or text content.
- Click the "Insert whiteboard" icon in the lower-left corner of the content to open the whiteboard and place the selected picture into the whiteboard.
- Click the "Delete" icon in the lower right corner of the content to delete the currently selected picture or text;
- Click the "Minimize" icon in the upper right corner of the application box and the easy upload application will be minimized. After the application is minimized, it will be displayed at the top of the page in the form of floating window.
- Click the "Close" icon in the upper right corner of the application box to close the easy upload app. After closing the app, all uploaded content will be cleared and no local saving will be performed.

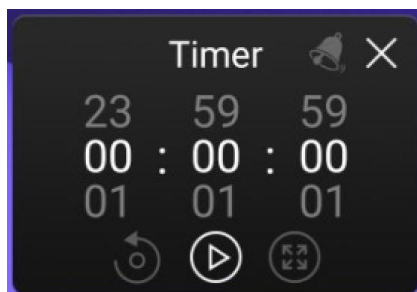

4.6.9. Timer



The functions of the timer and stopwatch in one are as follows:

Stopwatch

- Click the application icon to enter the application, and then the page will display 00:00:00.

- Click Start to enter stopwatch function.
- During the stopwatch's functioning, click to pause the timing. Click the reset button  on the left to reset the time to zero. Click  to enlarge the full-screen to enter the full screen display.
- Click "Close" in the upper right corner to close the application.

Countdown Function

- Click the application icon to enter the application, the page will display 00:00:00.
- Adjust the time to non-zero and enter the countdown function. Click "Start" to enter the official countdown.
- Click the bell icon to open the dot reminder function. When the countdown ends, the system will have a voice reminder.
- Click Reset to restore the preset countdown time.
- Click "Close" in the upper right corner to close the application.

4.6.10. Multi-users

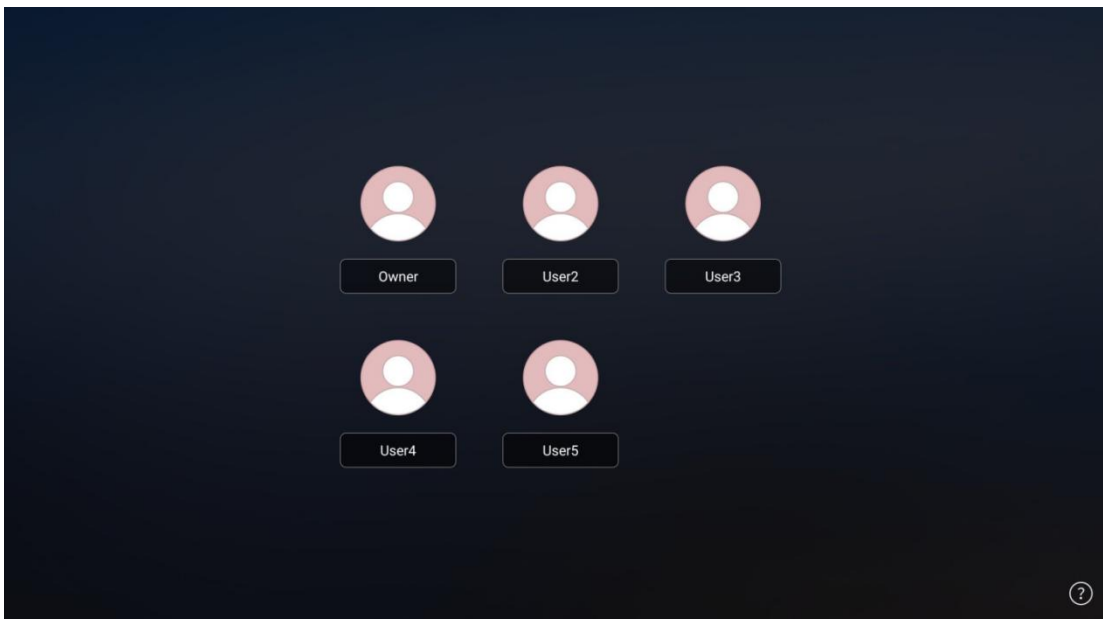

To solve the multi-purpose scenario of IFPD, the multi-user function is proposed. Multiple users have three permissions: primary user, common user, and visitor. Each device has a primary user by default. The primary user can access Settings,

System, and User to create and manage user accounts.

Add and enter multiple users

- (1) Under the main account, enter Settings -- System -- User, and turn on the multi-user switch to add a user.
- (2) Click "Add User" to enter the page for adding a user.
- (3) Type in the user name, role, and password to complete the creation.
- (4) After the addition, click "Exit current user" in the Launcher to enter the user switching page.
- (5) Select the user and input the password to enter the corresponding user management.

Multi-User Management

Primary users can manage users on the current device. Common users can only manage their own accounts. Visitor users have no account management rights.

Account management support:

- Changing passwords according to the scheme: Each user can set their own password to protect their privacy.
- Password reset: The primary user can reset the passwords of other users to prevent the user from being unable to access the account if the user password is lost.
- User name change: Click to edit the user name, replacing the current user name.

To delete an account, the primary user can delete other accounts, and all user information is deleted after an account is deleted.

4.7. Android Settings

4.7.1. Network

WLAN:

Turn on the wireless network and automatically scan the available wireless network nearby.

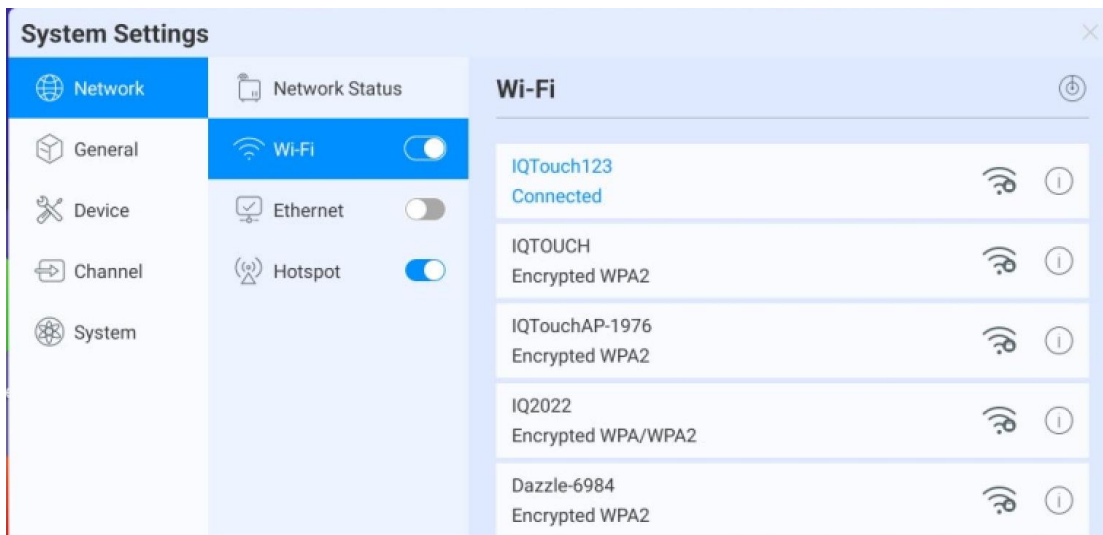

- On-Off: Turn on/off wireless network.
- Refresh: Click refresh icon in the top-right corner to refresh Network List.
- Add: Click Add button to fill in network name and password to add hidden network.
- Connect: Select the network click connection, fill in the password connection.

Ethernet

- Turn on the Ethernet network and open the IP option.
- Automatically access the IP connection network.
- Manually enter IP address, default gateway, subnet mask, DNS1/DNS2 settings.

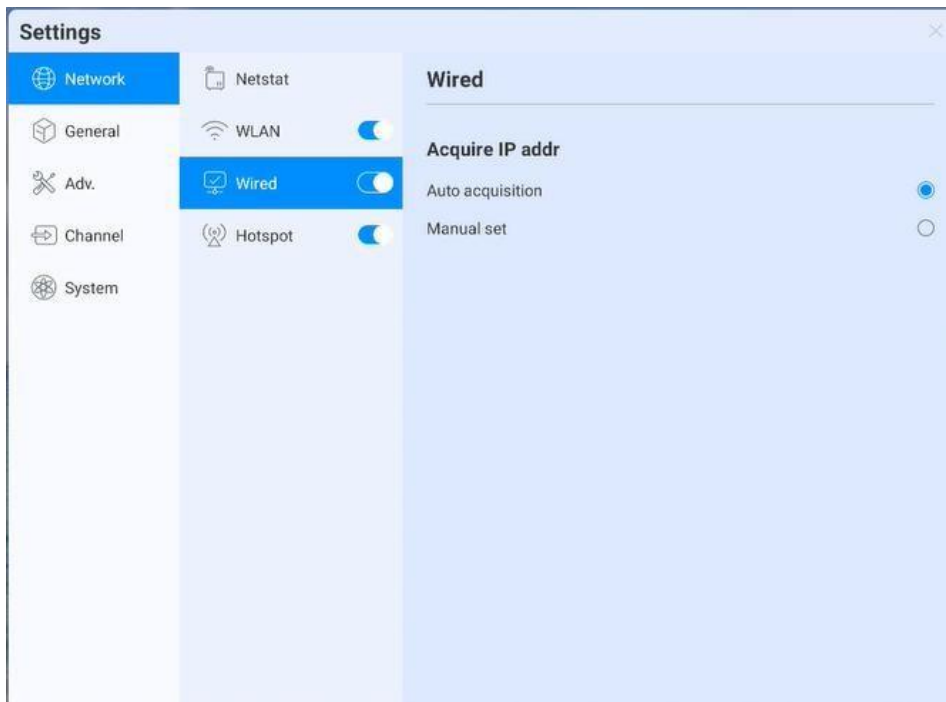

WiFi-AP (Hotspot)

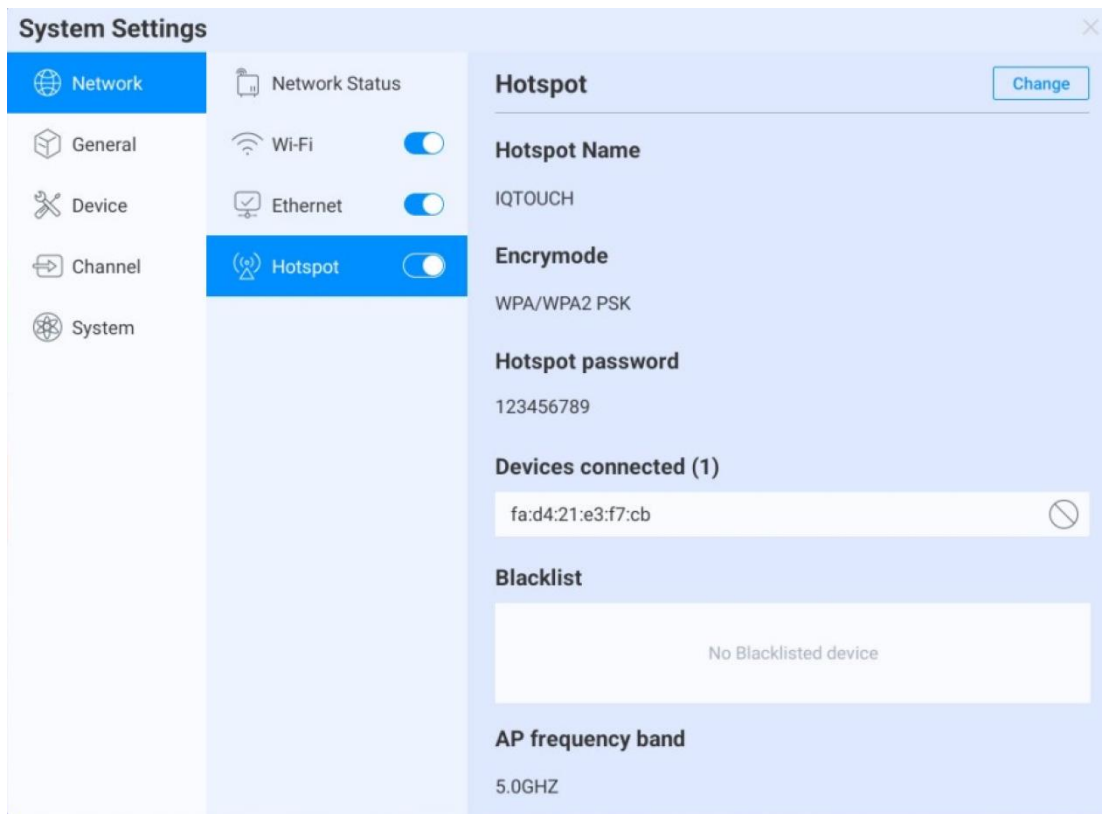

- WiFi-AP Password: Displays the current WiFi-AP password, click to change.

- Connected devices: Display connected devices.
- Blacklist: Display blacklisted devices which can not be connected.

4.7.2. General

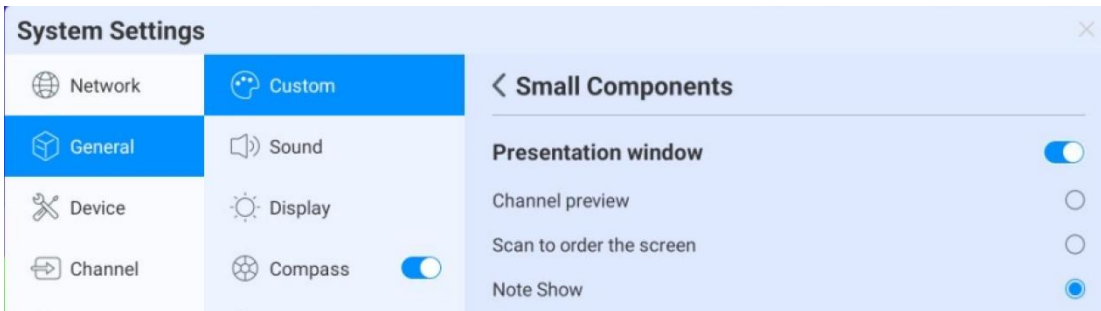
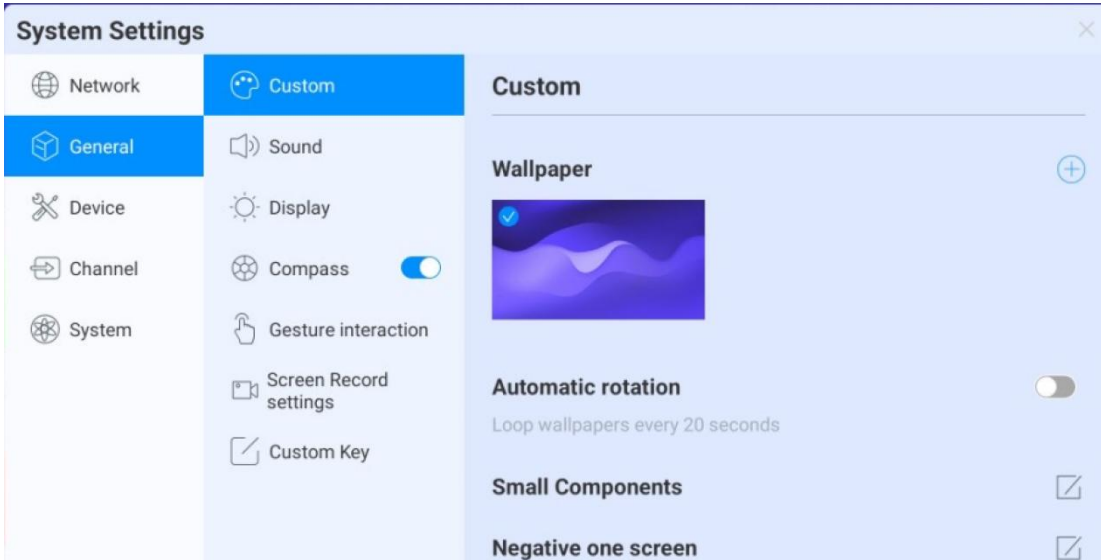

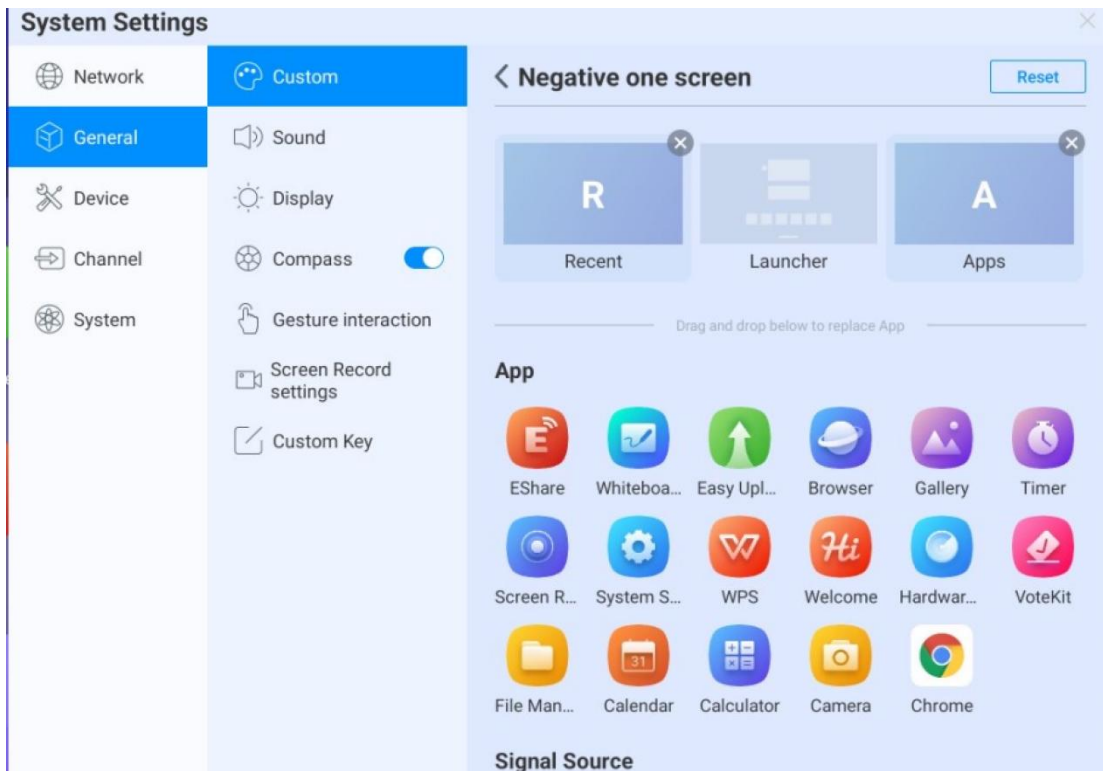

- Wallpaper: The system provides 10 pieces of wallpaper with automatic rotate multicast; click users can upload the customized wallpaper.
- Small Components: Prompt language switch, control whether page prompt language will display. Display window, can control the switch and display content, also can choose the two functions of sourcing and scanning code to occupy the screen.
- Negative screen: The negative screen is the page with the left and right slide into the Launcher home page. After entering the function, the user can drag the app to the corresponding page to take effect.

Sound

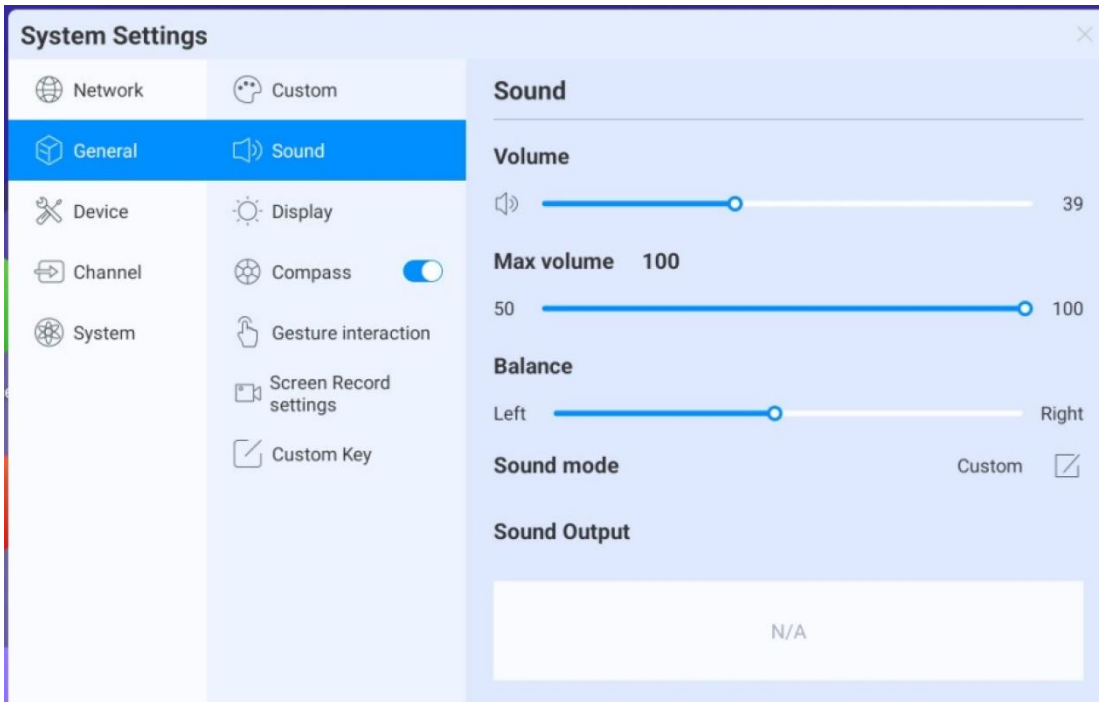

Sound setting is used to adjust the sound effects of the system :

- Volume: Adjust the volume, also can adjust by pushing the “volume+” and “volume-” button on remote control or device button.
- Maximum volume: Set the system maximum volume.
- Balance: Balance the left& right channels.
- Sound mode: preset standard, conference room, cinema, classroom four sound modes, but also supports customizing.

Display

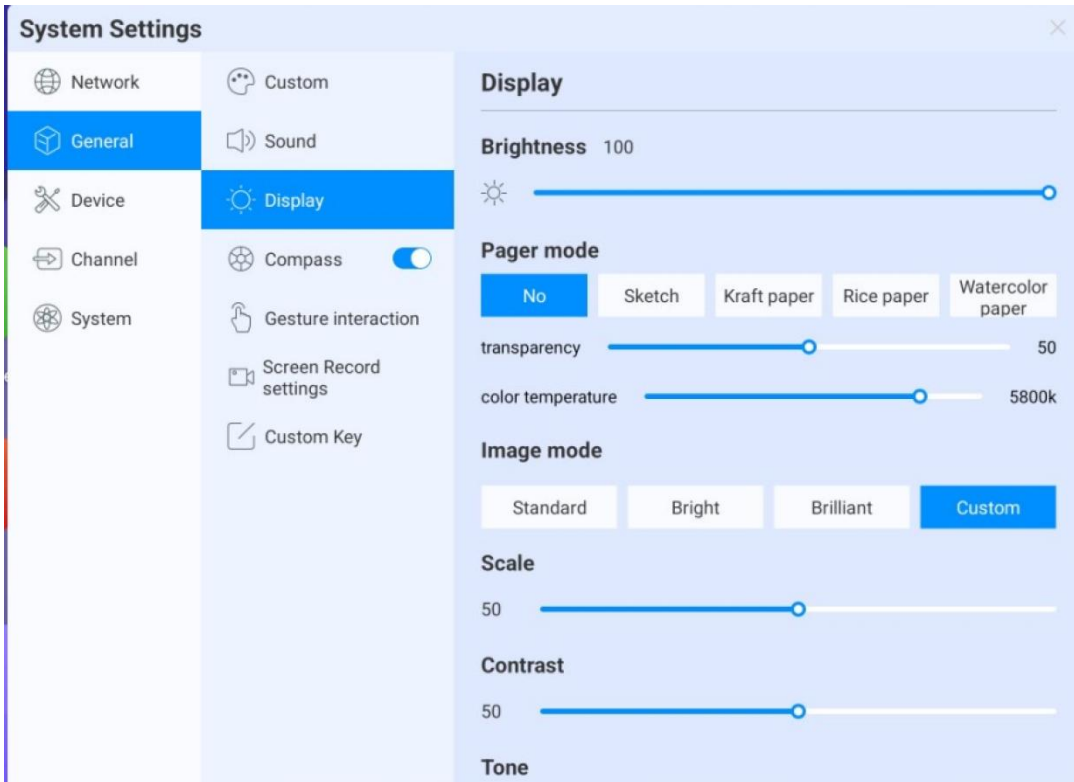

Display settings can adjust display effect of the screen.

- Brightness: Adjust backlight brightness, the lower the value, the darker the picture.
- Image mode: System default image mode: standard, bright, bright-colored, but also support customizing.

Compass

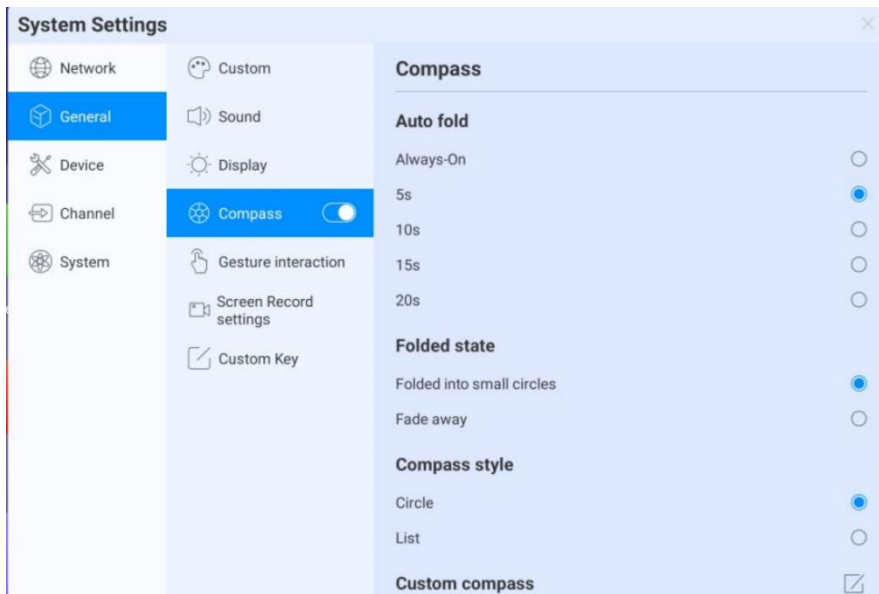

Compass setting is mainly to adjust the compass switch, display time, display style, and other functions, specifically as follows:

- **Switch:** Click the compass switch, you can switch the compass display state, it can not be called out under the closed state, you can long press the compass with five fingers to open the compass under the open state. **Automatically rewind time setting:** click to select the corresponding rewinding time.
- **Folded state:** Select “Folded into small circles” then the compass will be folded up into a small circle while the tool options around the small circle will be hidden. Tap the small circle to display the tool options. When you select “Fade away” the compass will disappear when it is folded and requires you to call it back using five fingers on the screen.
- **Compass form:** It supports two forms of wheel and list.
- **Compass customization:** You can customize the last three application icons on the compass, as the picture shows, drag the application to the location to add.

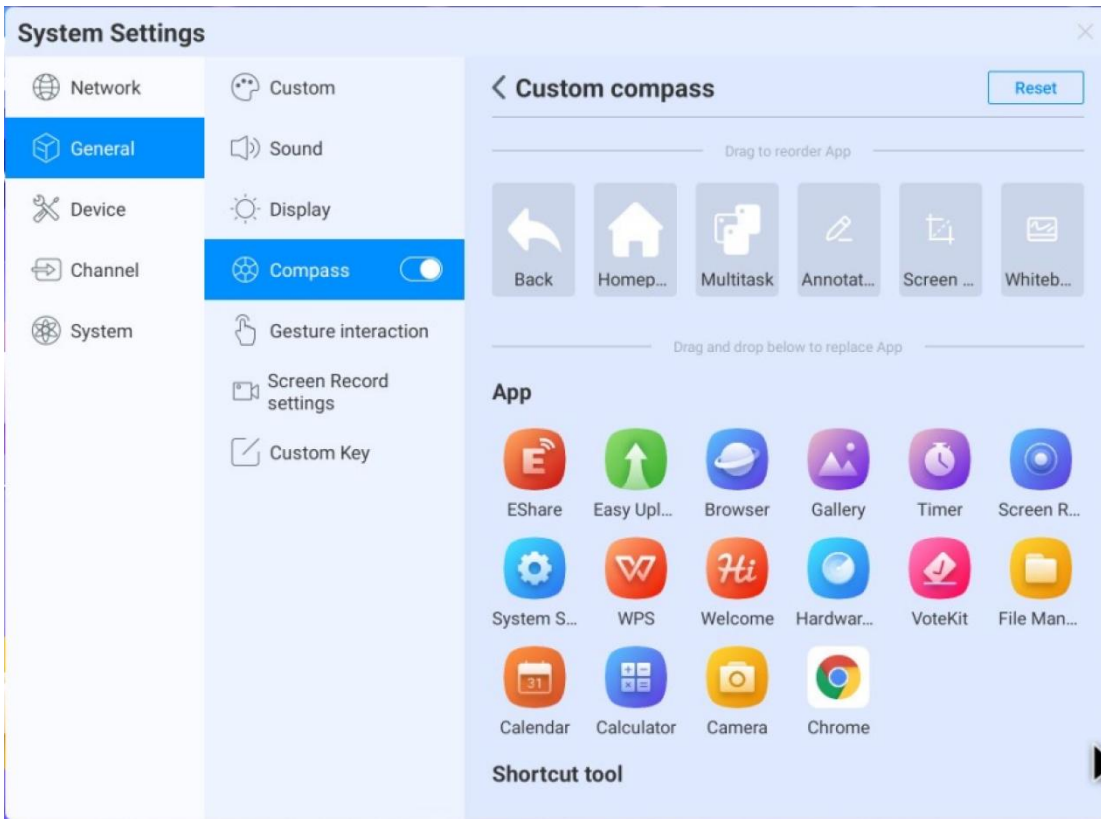

Gesture interaction

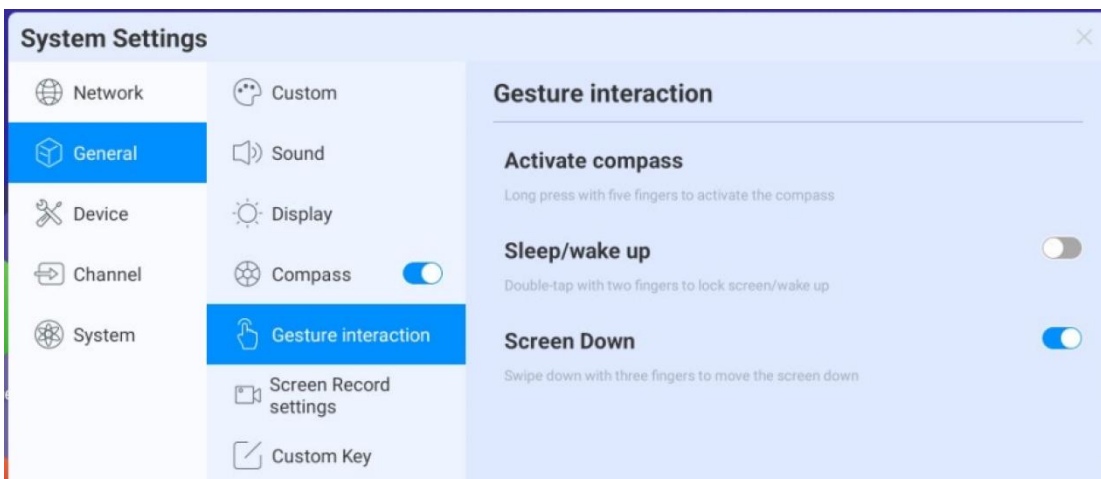

The system has preset some gesture interactions where the users can switch settings.

- Double click with two fingers to sleep or wake up the screen.
- Move down the screen: slide down with three fingers to move down the screen on channel page.

Screen recording

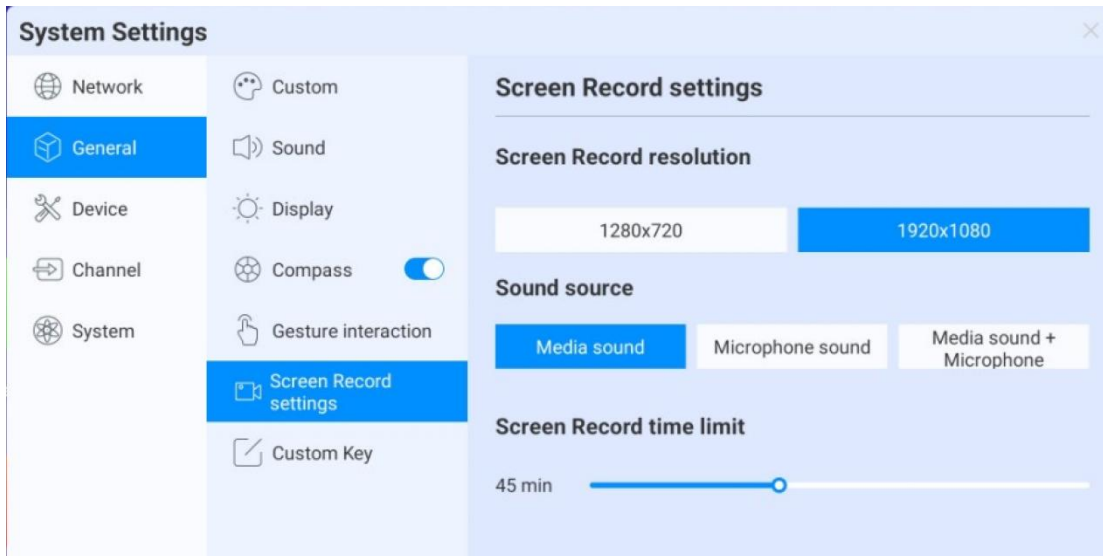

Preset the screen recording function, including:

- Recording resolution: Three resolutions are optional.
- Sound source: Set up the sound source for the screen recording remix.
- Recording time limit: Maximum recording time, when the maximum recording time is reached it will prompt to save.

Custom Key

Customize the Q button page by assigning custom functions to the Q button. As shown in the image, simply drag and drop the desired applications to the positions where you want to add them.

* The Q button is the original C button.

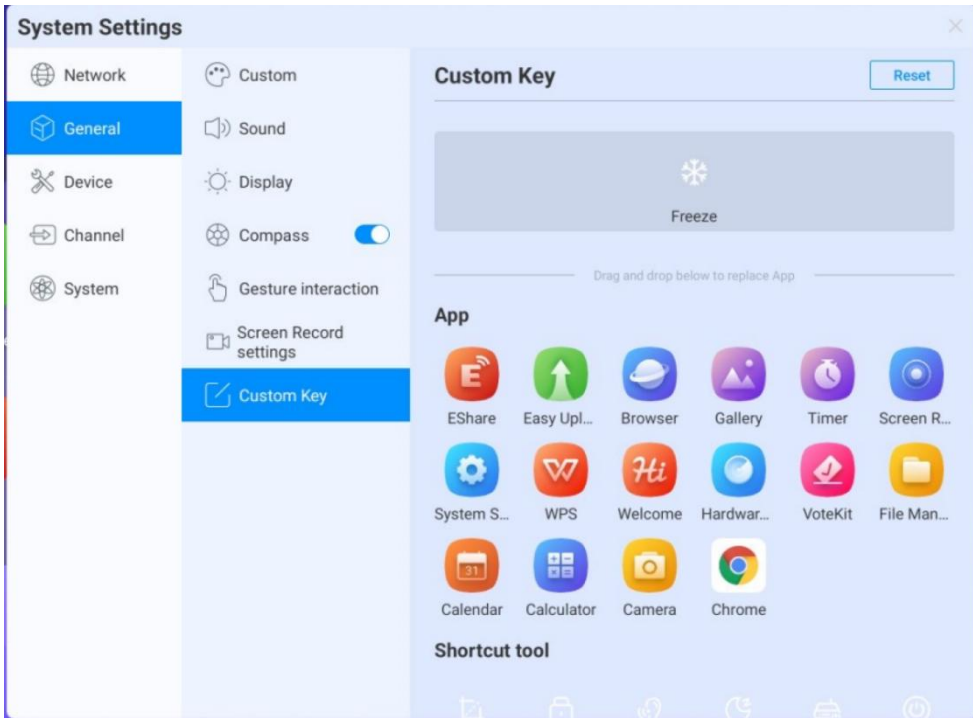

4.7.3. Device

Device control page, mainly adjusts the external equipment of the device, including Bluetooth and Bluetooth devices, printer, microphone, camera.

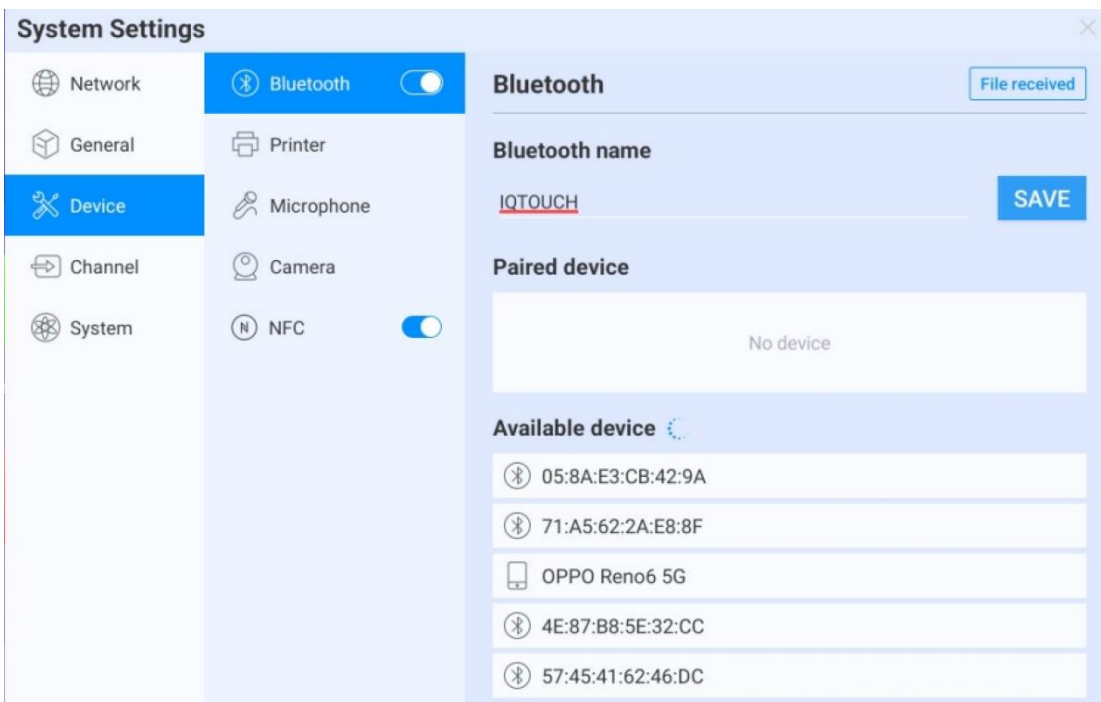

Bluetooth

- Bluetooth function depends on model configuration.
- Enable the Bluetooth functioned, you can search for devices and transfer files, or find and connect other Bluetooth devices (Including but not limited to mouse, keyboard, headset, audio, mobile devices, PC, universal/ unidentified devices).

Printer

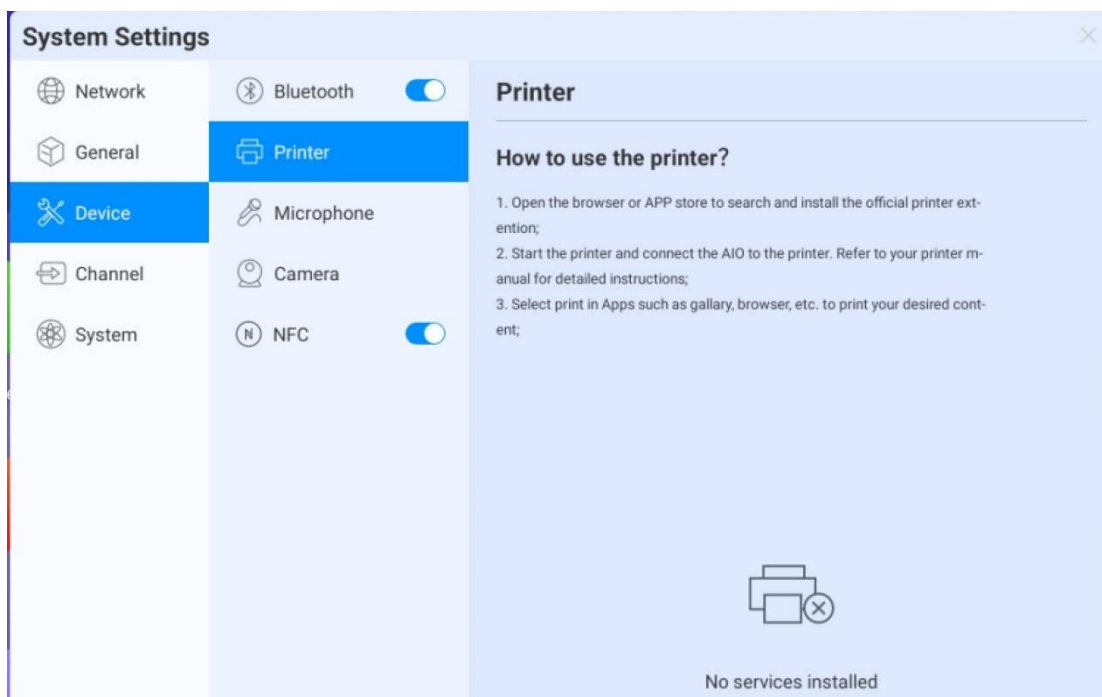

- Install the print service according to the instructions.
- Turn on the print service to get the available printer terminals.

Microphone

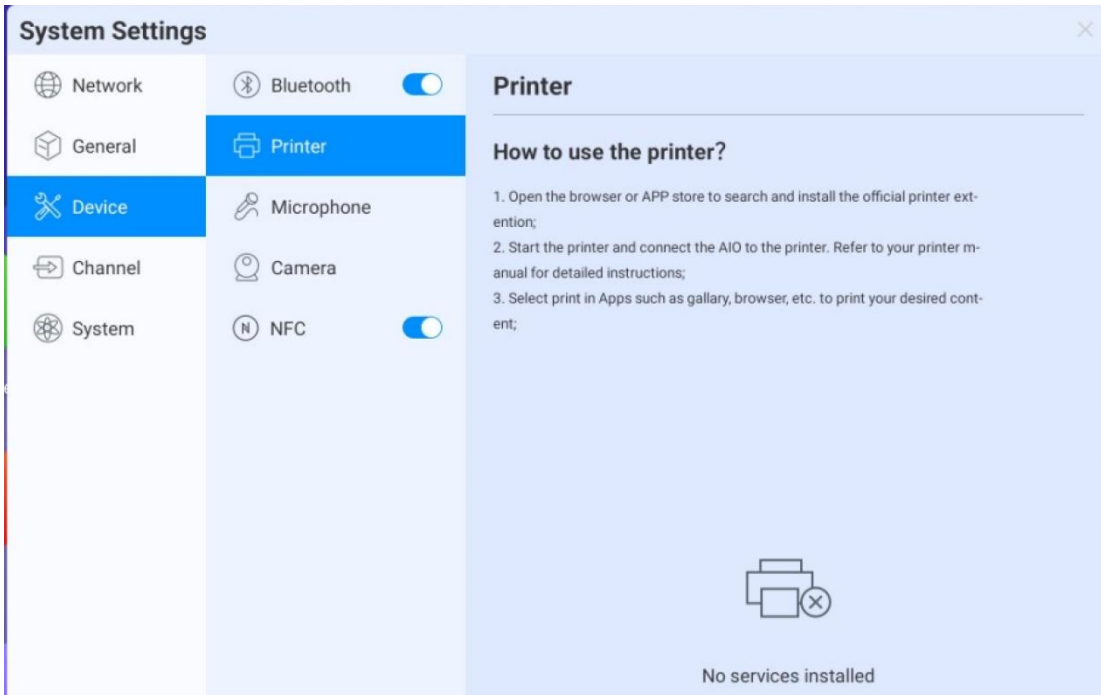

Microphone: View the connected microphone device, all devices are presented in the list, and click to switch.

Camera

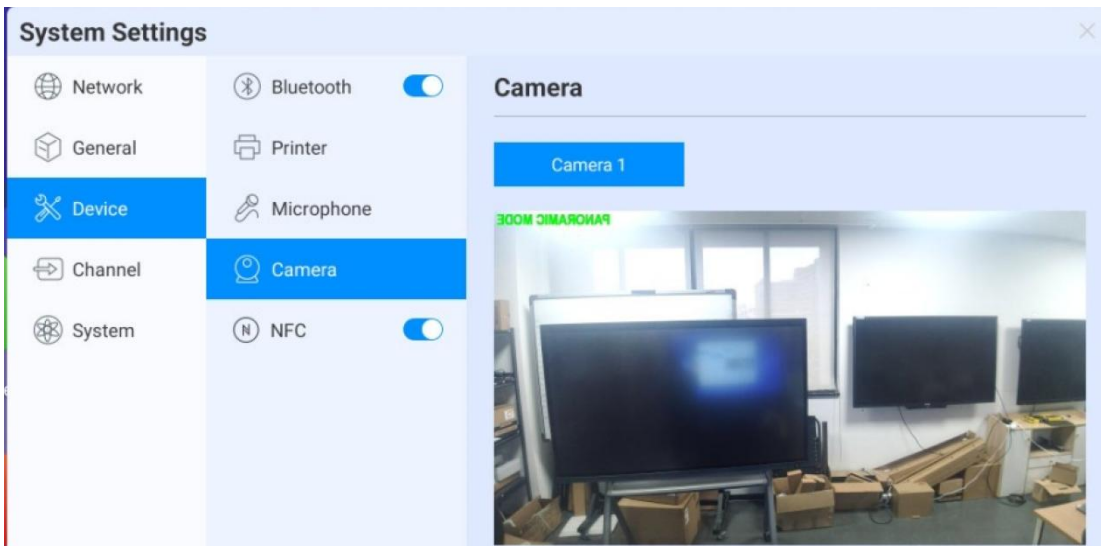

Camera: View the connected camera device, all devices are presented in the list, and click to switch.

NFC

On NFC page, you can add NFC cards to achieve specific functions using the NFC module.

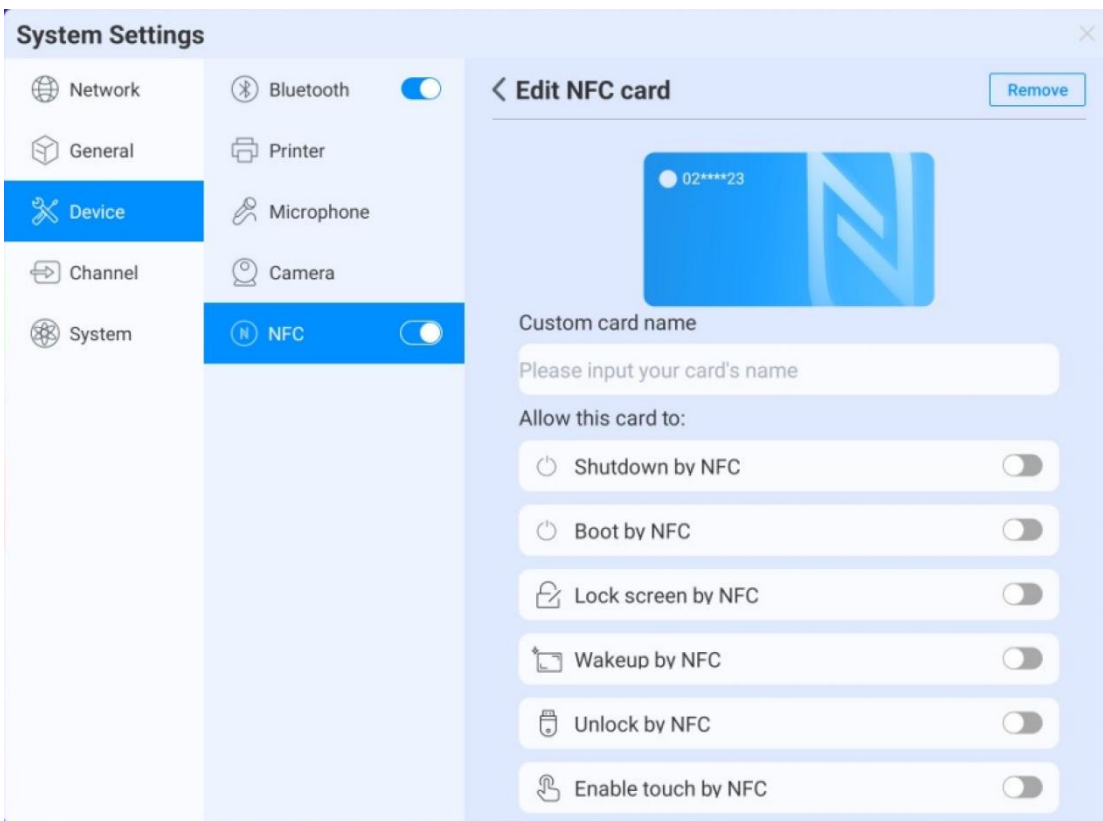
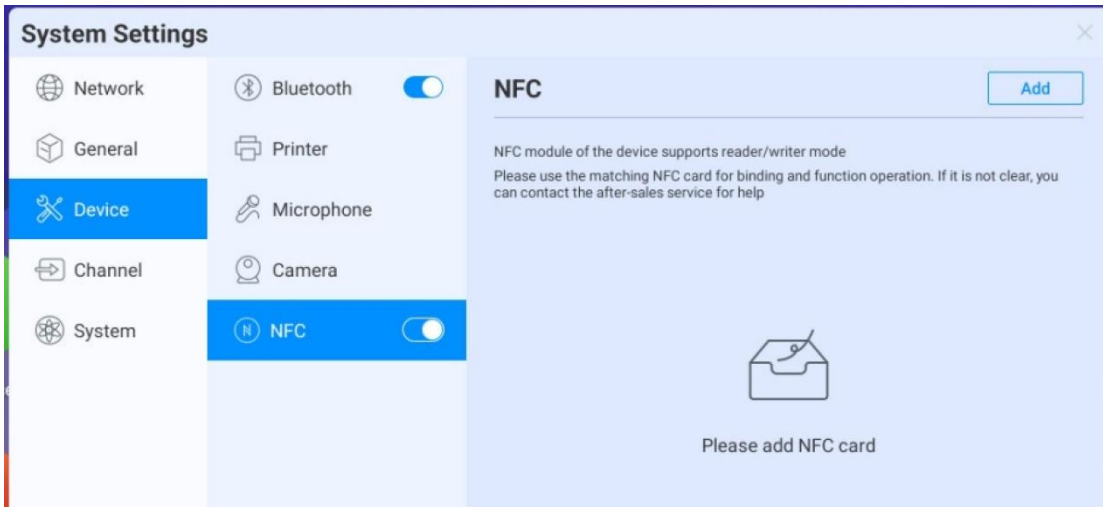

4.7.4. Input Channel

Channel image

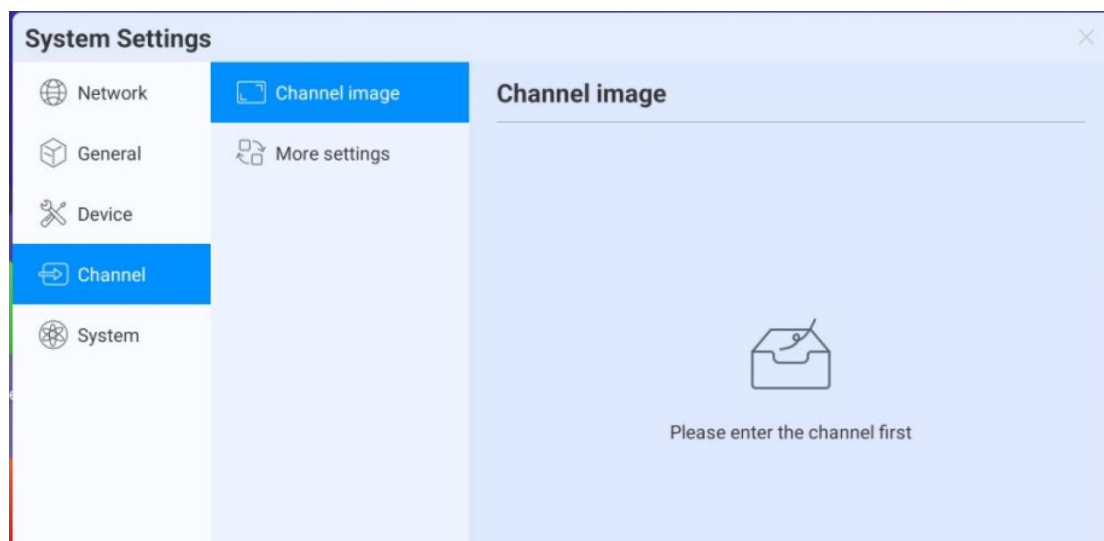

- Describes the status of the current access source.
- Scale mode: Set the display scale of the current input source.
- PC mode: Select screen display mode.

Other settings

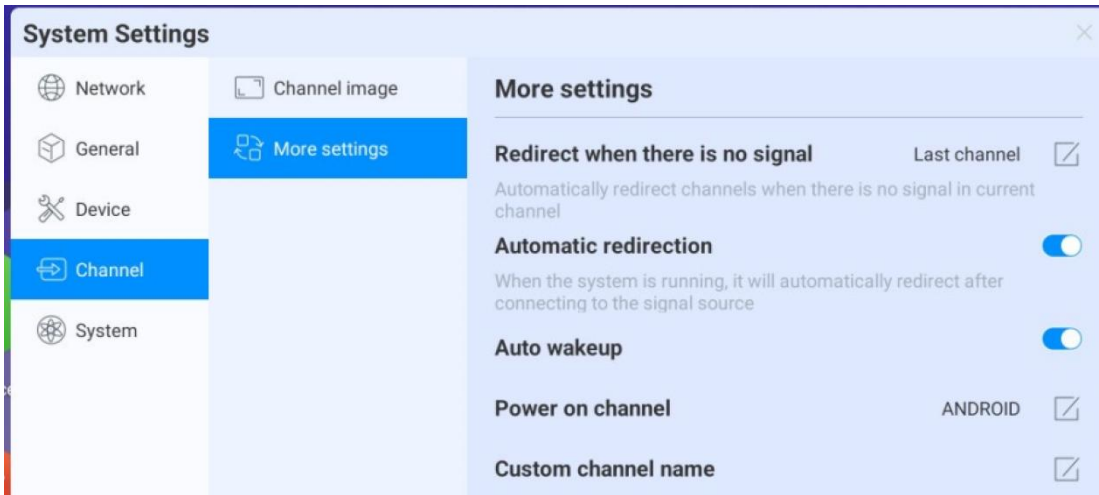

- No signal jump: If the current channel has no signal, the page will automatically switch, and the user can customize the jump page.
- Automatic jump: When the system is running, access the new signal source, it'll automatically jump to the corresponding channel.
- Automatic wake-up: Under standby or sleep state, access the signal source and automatically wake up the device.
- Boot channel: Set up to access to a channel after the boot, can be set to Android or any source interface.
- Channel name customization: There are many signal sources and names in the system, users can customize their familiar names, the system will display the new signal source name after customized.

4.7.5. System

The various system parameters can be adjusted and viewed in the system settings, including: Date and Time, Language and keyboard, Power state, System update, System security, and About.

Date and Time

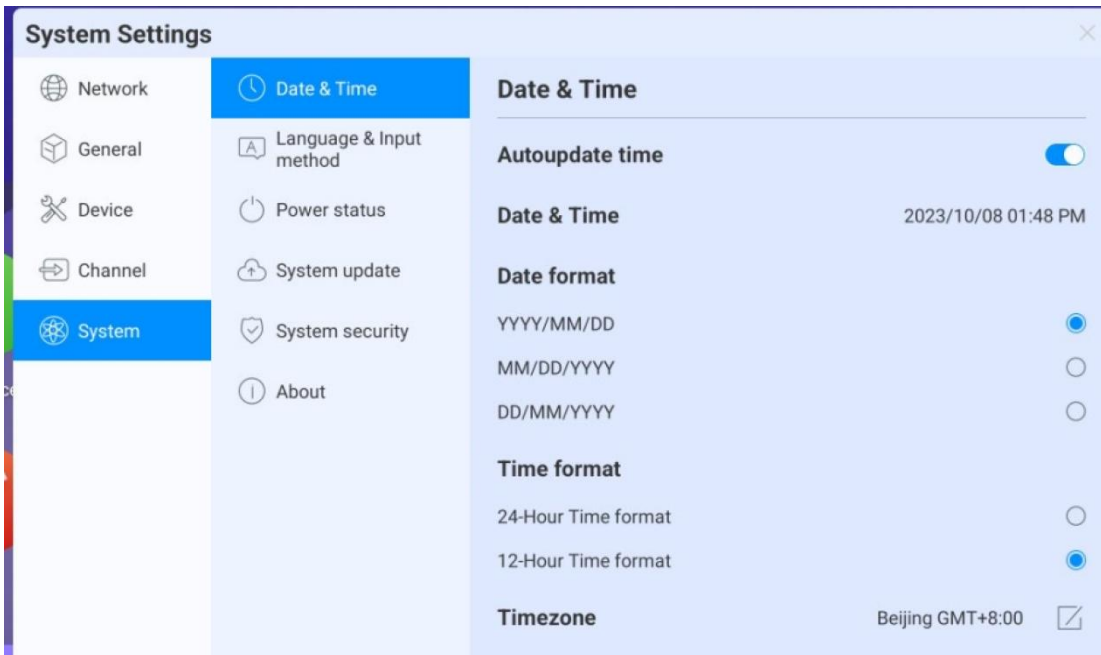

- Automatic update: Enable to synchronize network time(Need to connect to the Internet).
- Date and time: Turn off automatic update, click to adjust the date and time.
- Date format: Three date-display formats, according to your habit to choose one.
- Time format: Two time-display format, according to your habit to choose one.
- Time zone: Set time zone, click to enter the time zone selection list.

Language and keyboard

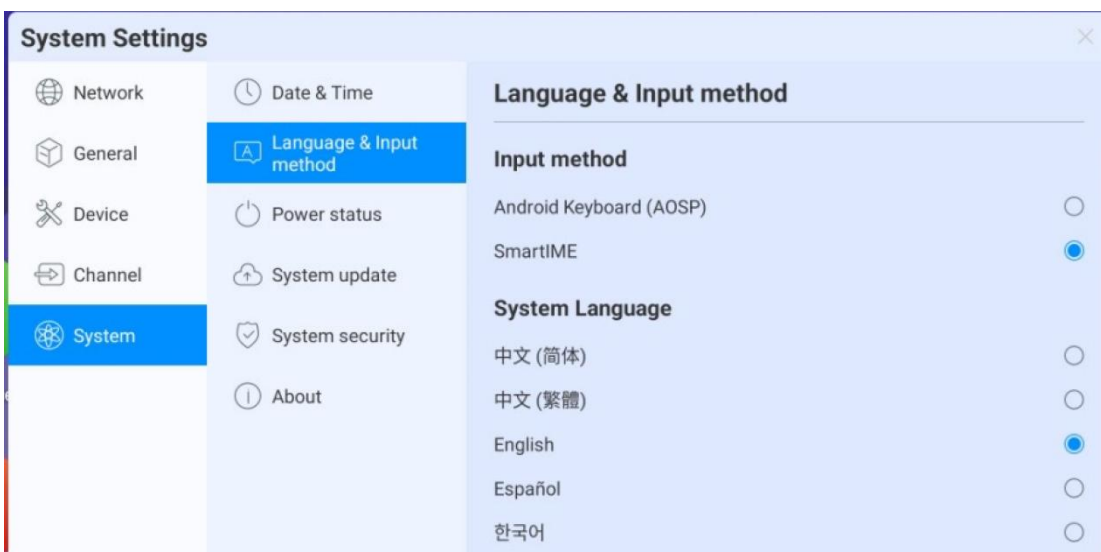

- Keyboard: Users can select input method here.

- **System Language:** System language can be switched in Simplified Chinese, Traditional Chinese, English, French, German, Russian, Japanese, Korean, Polish, Portuguese, Vietnamese, Spanish, Italian, and Arabic.

Power state

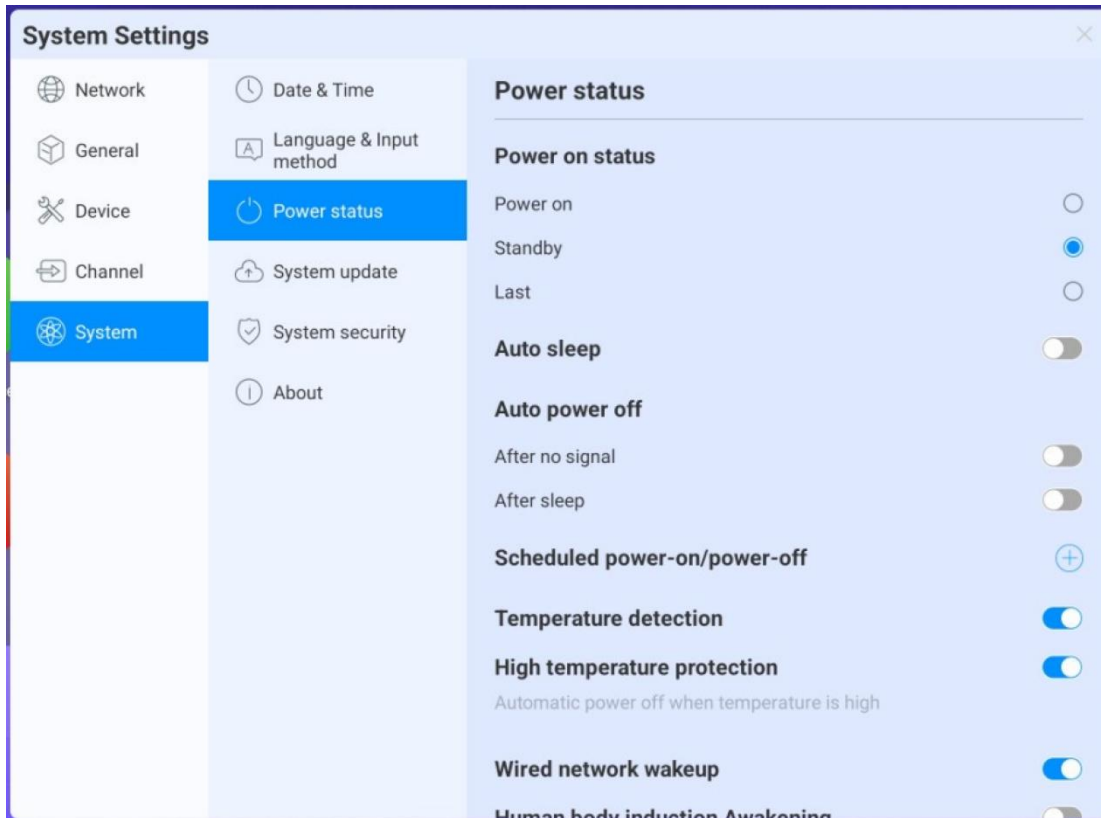

Power on: After opening, the device directly enters the boot state when it is powered on. Otherwise, the standby mode is used by default.

- **Automatic screen sleep:** Choose this function, set the screen rest time. The screen will turn off at the end of the screen sleep time.
- **Auto power off:** You can set the automatic power off mode, you can choose to automatically power off after no signal or automatic poweroff after screen sleep.
- **Auto On/Off:** Set a time to auto on/off.
- **Temperature detection:** The upper right corner status bar will display the current device temperature, you can see temperature status in the status bar.

- Temperature protection: When the temperature $\geq 85^{\circ}\text{C}$, it will shut down the display automatically for the display protection.

System update

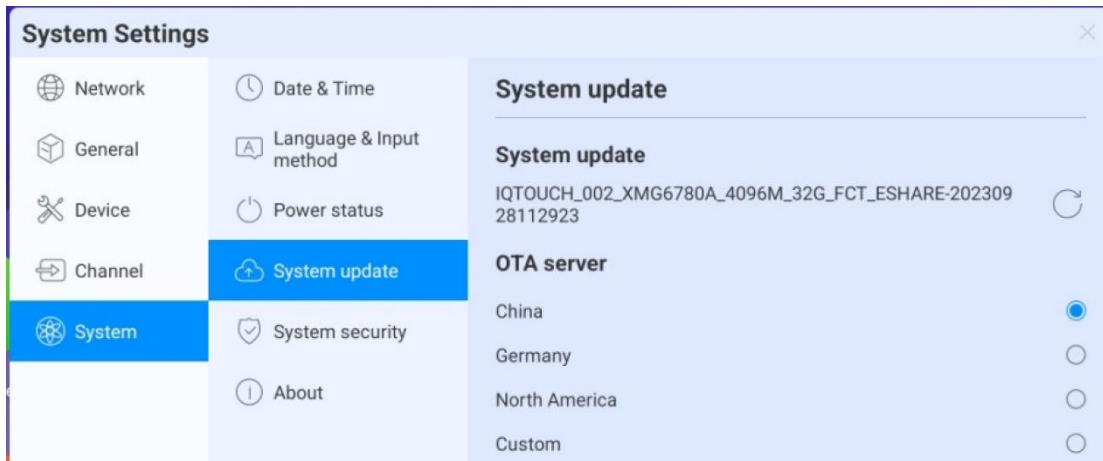

- System update: Display the current firmware version, click refresh to detect the latest version. When there is a new version, present the update version button, click to enter the upgrade process.
- OTA server: Use OTA push to detect new versions automatically in networking, you can customize OTA server address.

System security

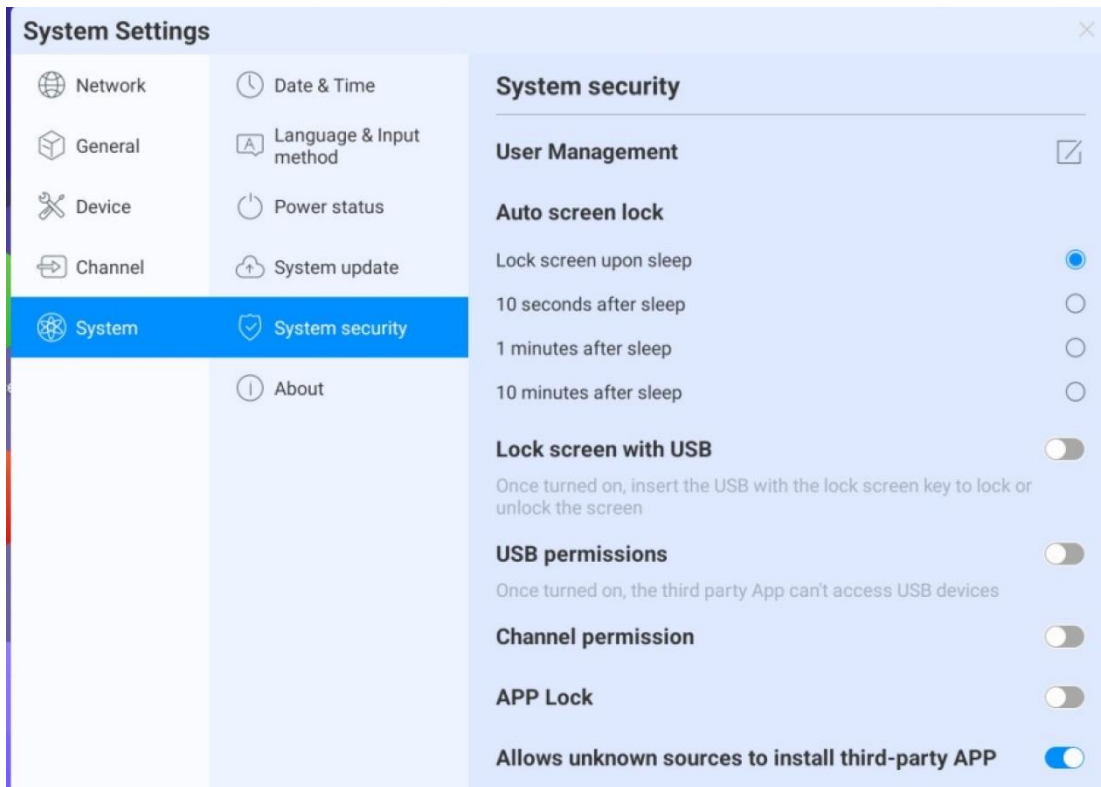

- Lock Screen: You can set the pattern or password to unlock. If you forget the password, you can only restore the equipment used by factory resets, please keep it properly.
- U Disk Lock Screen: Store the "usb_key" file in the root directory of the USB device. Automatically lock screen / unlock after receiving USB flash drive, no need to enter password to unlock.

U disk lock screen / unlock file

- 1)New text document.
- 2)Entering U2FsdGVkX19eyanxj43a24KpK3kZmzB9.
- 3)Name the file usb_key.
- 4)Delete the file suffix name .txt.
- 5)The character is UTF-8.
- 6)Save and place it in the root of U disk.
- 7)Insert the U disk to unlock.

- USB Permission: If the permission is enabled, USB reading is disabled to protect files from copies(you need to set a password at the first time, if you forget the password, you can only

restore the equipment used by factory reset, please keep it properly), you need to enter password to gain access to the USB stick.

- Allow third-party applications installation from unknown sources: Users can install third-party applications, or can only download and install applications from the Google Store.

Multi-user

Refer to the above, multi-user function introduction.

About

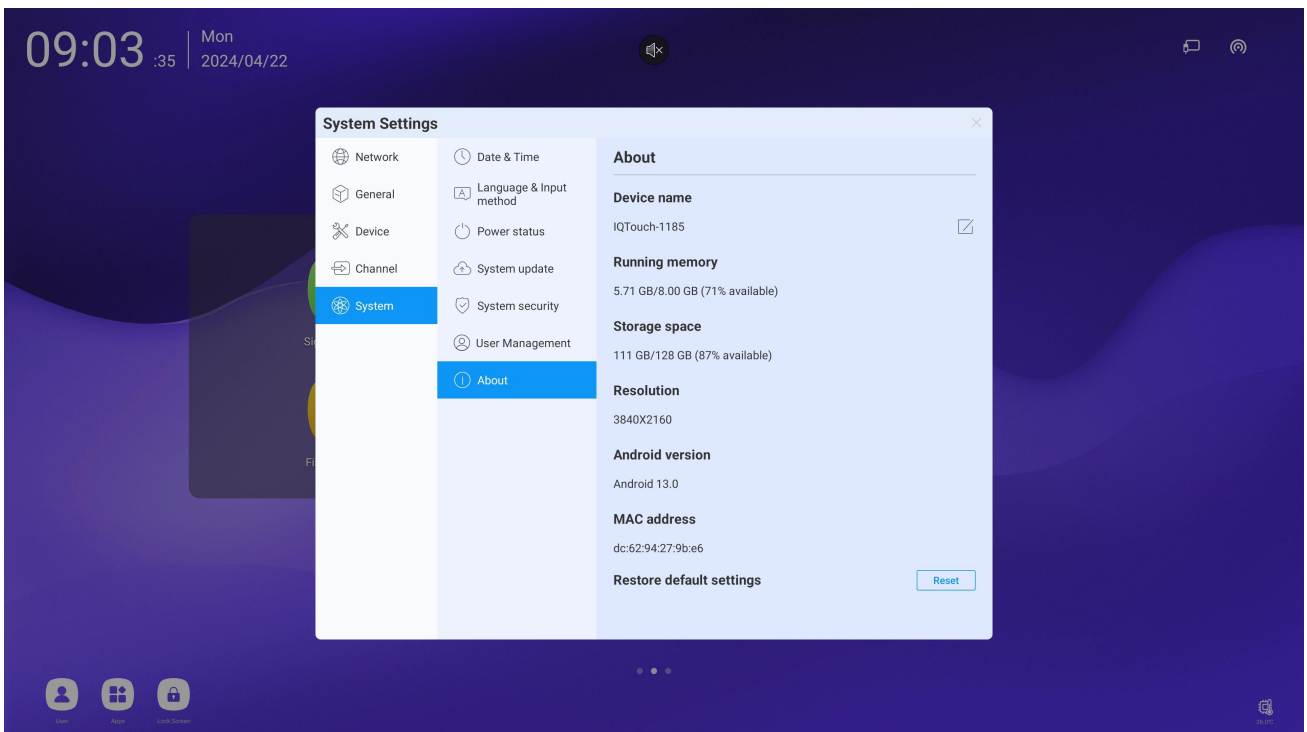

Click to view device information:

- Device name: Click on it to edit the device name.
- Factory reset: Factory reset will delete all operation records and content, and restore the device to the factory state.

5. Serial Port

RS232 communication cable (please use cross data cables)

PIN	This Device	Computer
1	NC	NC
2	RXD0	TXD0
3	TXD0	RXD0
4	NC	NC
5	GND	GND
6	NC	NC
7	NC	NC
8	NC	NC
9	NC	NC
Cover	GND	GND

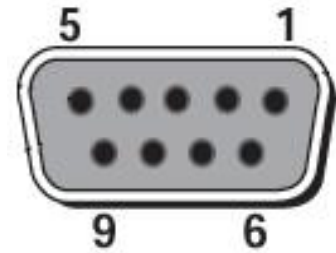

RS232 port of panel

Connect RS-232 port to the PC or controlling product. Enable RS-232 serial port connection and complete the following configuration.

Port: COM1 (Set according to PC or controlling product's port number)			
Baud rate	115200	Odd/even check	None
Data bits	8	Stop bit	1

The following tables list controlling codes, querying codes and return codes.

Type	Function	Controlling code	Return code
Overall	Power on	FE 08 58 42 48 43 4D 44 01 F0 CF	FE 09 58 42 48 43 4D 44 01 F0 01 CF
	Power off	FE 08 58 42 48 43 4D 44 01 F1 CF	FE 09 58 42 48 43 4D 44 01 F1 01 CF
	dormancy	FE 08 58 42 48 43 4D 44 01 F2 CF	FE 09 58 42 48 43 4D 44 01 F2 01 CF

	Exit hibernation	FE 08 58 42 48 43 4D 44 01 F3 CF	FE 09 58 42 48 43 4D 44 01 F3 01 CF
	Get Device status	FE 08 58 42 48 43 4D 44 02 08 CF	FE 09 58 42 48 43 4D 44 02 08 XX CF
	Restart the system	FE 08 58 42 48 43 4D 44 01 43 CF	FE 09 58 42 48 43 4D 44 01 43 01 CF
	Android system restore (restore factory settings)	FE 08 58 42 48 43 4D 44 01 44 CF	FE 09 58 42 48 43 4D 44 01 44 01 CF
	Get Android version	FE 08 58 42 48 43 4D 44 02 21 CF	FE LL 58 42 48 43 4D 44 02 21 X1 X2 ... Xn CF
	Get the mainboard software model name	FE 08 58 42 48 43 4D 44 02 27 CF	FE LL 58 42 48 43 4D 44 02 27 X1 X2 ... Xn CF
	Get machine SN	FE 08 58 42 48 43 4D 44 02 28 CF	FE LL 58 42 48 43 4D 44 02 28 X1 X2 ... Xn CF
	Get machine temperature	FE 08 58 42 48 43 4D 44 02 33 CF	FE 09 58 42 48 43 4D 44 02 33 XX CF
	Set language	FE 09 58 42 48 43 4D 44 03 0F XX CF	FE 0A 58 42 48 43 4D 44 03 0F XX YY CF
	Get language	FE 08 58 42 48 43 4D 44 02 0F CF	FE 09 58 42 48 43 4D 44 02 0F XX CF
	Get current channel	FE 08 58 42 48 43 4D 44 02 39 CF	FE 09 58 42 48 43 4D 44 02 39 XX CF
Source management	signal source	FE 08 58 42 48 43 4D 44 01 11 CF	FE 09 58 42 48 43 4D 44 01 11 01 CF
	HD1 (HDMI1)	FE 08 58 42 48 43 4D 44 01 03 CF	FE 09 58 42 48 43 4D 44 01 03 01 CF
	HD2 (HDMI2)	FE 08 58 42 48 43 4D 44 01 04 CF	FE 09 58 42 48 43 4D 44 01 04 01 CF
	OPS computer (HDMI6)	FE 08 58 42 48 43 4D 44 01 08 CF	FE 09 58 42 48 43 4D 44 01 08 01 CF
	DP	FE 08 58 42 48 43 4D 44 01 09 CF	FE 09 58 42 48 43 4D 44 01 09 01 CF
	Front HDMI1	FE 08 58 42 48 43 4D 44 05 02 CF	FE 09 58 42 48 43 4D 44 05 02 01 CF
	TYPEC	FE 08 58 42 48 43 4D 44 05 05 CF	FE 09 58 42 48 43 4D 44 05 05 01 CF
	TYPEC2	FE 08 58 42 48 43 4D 44 05 06 CF	FE 09 58 42 48 43 4D 44 05 06 01 CF
	Set the default channel for power on	FE 09 58 42 48 43 4D 44 03 0B XX CF	FE 0A 58 42 48 43 4D 44 03 0B XX YY CF
	Get the default channel for power on	FE 08 58 42 48 43 4D 44 02 0B CF	FE 09 58 42 48 43 4D 44 02 0B XX CF
Numeric key	1	FE 08 58 42 48 43 4D 44 01 21 CF	FE 09 58 42 48 43 4D 44 01 21 01 CF
	2	FE 08 58 42 48 43 4D 44 01 22 CF	FE 09 58 42 48 43 4D 44 01 22 01 CF
	3	FE 08 58 42 48 43 4D 44 01 23 CF	FE 09 58 42 48 43 4D 44 01 23 01 CF
	4	FE 08 58 42 48 43 4D 44 01 24 CF	FE 09 58 42 48 43 4D 44 01 24 01 CF
	5	FE 08 58 42 48 43 4D 44 01 25 CF	FE 09 58 42 48 43 4D 44 01 25 01 CF

	6	FE 08 58 42 48 43 4D 44 01 26 CF	FE 09 58 42 48 43 4D 44 01 26 01 CF
	7	FE 08 58 42 48 43 4D 44 01 27 CF	FE 09 58 42 48 43 4D 44 01 27 01 CF
	8	FE 08 58 42 48 43 4D 44 01 28 CF	FE 09 58 42 48 43 4D 44 01 28 01 CF
	9	FE 08 58 42 48 43 4D 44 01 29 CF	FE 09 58 42 48 43 4D 44 01 29 01 CF
	0	FE 08 58 42 48 43 4D 44 01 2A CF	FE 09 58 42 48 43 4D 44 01 2A 01 CF
UI navigation	OK	FE 08 58 42 48 43 4D 44 01 2B CF	FE 09 58 42 48 43 4D 44 01 2B 01 CF
	←	FE 08 58 42 48 43 4D 44 01 2C CF	FE 09 58 42 48 43 4D 44 01 2C 01 CF
	→	FE 08 58 42 48 43 4D 44 01 2D CF	FE 09 58 42 48 43 4D 44 01 2D 01 CF
	↑	FE 08 58 42 48 43 4D 44 01 2E CF	FE 09 58 42 48 43 4D 44 01 2E 01 CF
	↓	FE 08 58 42 48 43 4D 44 01 2F CF	FE 09 58 42 48 43 4D 44 01 2F 01 CF
	page up	FE 08 58 42 48 43 4D 44 01 15 CF	FE 09 58 42 48 43 4D 44 01 15 01 CF
	page down	FE 08 58 42 48 43 4D 44 01 16 CF	FE 09 58 42 48 43 4D 44 01 16 01 CF
	homepage	FE 08 58 42 48 43 4D 44 01 0E CF	FE 09 58 42 48 43 4D 44 01 0E 01 CF
	Return (exit)	FE 08 58 42 48 43 4D 44 01 1D CF	FE 09 58 42 48 43 4D 44 01 1D 01 CF
Playback control	Play / pause	FE 08 58 42 48 43 4D 44 01 3C CF	FE 09 58 42 48 43 4D 44 01 3C 01 CF
	stop play	FE 08 58 42 48 43 4D 44 01 3D CF	FE 09 58 42 48 43 4D 44 01 3D 01 CF
	previous	FE 08 58 42 48 43 4D 44 01 3E CF	FE 09 58 42 48 43 4D 44 01 3E 01 CF
	next	FE 08 58 42 48 43 4D 44 01 3F CF	FE 09 58 42 48 43 4D 44 01 3F 01 CF
Apply shortcut keys	Factory menu	FE 08 58 42 48 43 4D 44 01 40 CF	FE 09 58 42 48 43 4D 44 01 40 01 CF
	File manager	FE 08 58 42 48 43 4D 44 01 41 CF	FE 09 58 42 48 43 4D 44 01 41 01 CF
	Whiteboard	FE 08 58 42 48 43 4D 44 01 10 CF	FE 09 58 42 48 43 4D 44 01 10 01 CF
	share screen	FE 08 58 42 48 43 4D 44 01 42 CF	FE 09 58 42 48 43 4D 44 01 42 01 CF
	Settings	FE 08 58 42 48 43 4D 44 01 0F CF	FE 09 58 42 48 43 4D 44 01 0F 01 CF
	Annotation	FE 08 58 42 48 43 4D 44 01 61 CF	FE 09 58 42 48 43 4D 44 01 61 01 CF
	Welcome page	FE 08 58 42 48 43 4D 44 01 62 CF	FE 09 58 42 48 43 4D 44 01 62 01 CF
	Start timer timing	FE 0B 58 42 48 43 4D 44 01 67 HH MM SS CF	FE 0C 58 42 48 43 4D 44 01 67 HH MM SS YY CF
	Pause timer timing	FE 08 58 42 48 43 4D 44 01 68 CF	FE 09 58 42 48 43 4D 44 01 68 01 CF
	Reset timer timing	FE 08 58 42 48 43 4D 44 01 69 CF	FE 09 58 42 48 43 4D 44 01 69 01 CF
	End timer timing	FE 08 58 42 48 43 4D 44 01 6A CF	FE 09 58 42 48 43 4D 44 01 6A 01 CF

Sound management	Set mute / unmute	FE 09 58 42 48 43 4D 44 03 12 XX CF	FE 0A 58 42 48 43 4D 44 03 12 XX YY CF
	Get mute status	FE 08 58 42 48 43 4D 44 02 12 CF	FE 09 58 42 48 43 4D 44 02 12 XX CF
	mute	FE 08 58 42 48 43 4D 44 01 14 CF	FE 09 58 42 48 43 4D 44 01 14 01 CF
	Get volume	FE 09 58 42 48 43 4D 44 03 03 XX CF	FE 0A 58 42 48 43 4D 44 03 03 XX YY CF
	Get volume	FE 08 58 42 48 43 4D 44 02 03 CF	FE 09 58 42 48 43 4D 44 02 03 XX CF
	Sound -	FE 08 58 42 48 43 4D 44 01 18 CF	FE 09 58 42 48 43 4D 44 01 18 XX CF
	Sound +	FE 08 58 42 48 43 4D 44 01 19 CF	FE 09 58 42 48 43 4D 44 01 19 XX CF
Image management	Set image mode	FE 09 58 42 48 43 4D 44 03 02 XX CF	FE 0A 58 42 48 43 4D 44 03 02 XX YY CF
	Get image mode	FE 08 58 42 48 43 4D 44 02 02 CF	FE 09 58 42 48 43 4D 44 02 02 XX CF
	Set image contrast	FE 09 58 42 48 43 4D 44 03 21 XX CF	FE 0A 58 42 48 43 4D 44 03 21 XX YY CF
	Get image contrast	FE 08 58 42 48 43 4D 44 02 34 CF	FE 09 58 42 48 43 4D 44 02 34 XX CF
	Set image brightness	FE 09 58 42 48 43 4D 44 03 22 XX CF	FE 0A58 42 48 43 4D 44 03 22 XX YY CF
	Get image brightness	FE 08 58 42 48 43 4D 44 02 35 CF	FE 09 58 42 48 43 4D 44 02 35 XX CF
	Set image saturation	FE 09 58 42 48 43 4D 44 03 24 XX CF	FE 0A58 42 48 43 4D 44 03 24 XX YY CF
	Get image saturation	FE 08 58 42 48 43 4D 44 02 40 CF	FE 09 58 42 48 43 4D 44 02 40 XX CF
	Set image sharpness	FE 09 58 42 48 43 4D 44 03 25 XX CF	FE 0A58 42 48 43 4D 44 03 25 XX YY CF
	Get image sharpness	FE 08 58 42 48 43 4D 44 02 41 CF	FE 09 58 42 48 43 4D 44 02 41 XX CF
Backlight management	Set backlight brightness	FE 09 58 42 48 43 4D 44 03 04 XX CF	FE 0A 58 42 48 43 4D 44 03 04 XX YY CF
	Get backlight brightness value	FE 08 58 42 48 43 4D 44 02 04 CF	FE 09 58 42 48 43 4D 44 02 04 XX CF
	Set backlight mode	FE 09 58 42 48 43 4D 44 03 05 XX CF	FE 0A 58 42 48 43 4D 44 03 05 XX YY CF
	Get backlight mode	FE 08 58 42 48 43 4D 44 02 05 CF	FE 09 58 42 48 43 4D 44 02 05 XX CF
	Get backlight switch status	FE 08 58 42 48 43 4D 44 02 0A CF	FE 09 58 42 48 43 4D 44 02 0A XX CF
	Set backlight switch status	FE 09 58 42 48 43 4D 44 03 0A XX CF	FE 0A 58 42 48 43 4D 44 03 0A XX YY CF

Authority management	Turn on child lock mode	FE 09 58 42 48 43 4D 44 03 07 01 CF	FE 0A 58 42 48 43 4D 44 03 07 01 XX CF
	Turn off child lock mode	FE 09 58 42 48 43 4D 44 03 07 00 CF	FE 0A 58 42 48 43 4D 44 03 07 00 XX CF
	Get child lock mode status	FE 08 58 42 48 43 4D 44 02 07 CF	FE 09 58 42 48 43 4D 44 02 07 XX CF
	set the key board disable / enable	FE 09 58 42 48 43 4D 44 03 10 XX CF	FE 0A 58 42 48 43 4D 44 03 10 XX YY CF
	Get the disable some / disable / enable status of key board	FE 08 58 42 48 43 4D 44 02 10 CF	FE 09 58 42 48 43 4D 44 02 10 XX CF
	Disable some / Disable / Enable remote control keys	FE 09 58 42 48 43 4D 44 03 11 XX CF	FE 0A 58 42 48 43 4D 44 03 11 XX YY CF
	Get the disabled/enable status of remote control keys	FE 08 58 42 48 43 4D 44 02 11 CF	FE 09 58 42 48 43 4D 44 02 11 XX CF
Function Shortcuts Key	Listen alone	FE 08 58 42 48 43 4D 44 01 17 CF	FE 09 58 42 48 43 4D 44 01 17 01 CF
	display	FE 08 58 42 48 43 4D 44 01 12 CF	FE 09 58 42 48 43 4D 44 01 12 01 CF
	Screenshot	FE 08 58 42 48 43 4D 44 01 1E CF	FE 09 58 42 48 43 4D 44 01 1E 01 CF
	zoom	FE 08 58 42 48 43 4D 44 01 20 CF	FE 09 58 42 48 43 4D 44 01 20 XX CF
Peripheral management	Get OPS power status	FE 08 58 42 48 43 4D 44 02 13 CF	FE 09 58 42 48 43 4D 44 02 13 XX CF
	Set OPS power status	FE 09 58 42 48 43 4D 44 03 13 XX CF	FE 0A 58 42 48 43 4D 44 03 13 XX YY CF
Network management	Turn wired network on / off	FE 09 58 42 48 43 4D 44 03 16 XX CF	FE 0A 58 42 48 43 4D 44 03 16 XX YY CF
	Get wired network switch status	FE 08 58 42 48 43 4D 44 02 16 CF	FE 09 58 42 48 43 4D 44 02 16 XX CF
	Turn wireless network switch on / off	FE 09 58 42 48 43 4D 44 03 17 XX CF	FE 0A 58 42 48 43 4D 44 03 17 XX YY CF
	Get wireless network switch status	FE 08 58 42 48 43 4D 44 02 17 CF	FE 09 58 42 48 43 4D 44 02 17 XX CF
	WiFi-HotSpot switch	FE 09 58 42 48 43 4D 44 03 18 XX CF	FE 0A 58 42 48 43 4D 44 03 18 XX YY CF
	Get WiFi-HotSpot switch status	FE 08 58 42 48 43 4D 44 02 18 CF	FE 09 58 42 48 43 4D 44 02 18 XX CF
	Get wired MAC address of Android system	FE 08 58 42 48 43 4D 44 02 09 CF	FE 0E 58 42 48 43 4D 44 02 09 X1 X2 X3 X4 X5 X6 CF
Touch management	Touch lock	FE 09 58 42 48 43 4D 44 03 06 00 CF	FE 0A 58 42 48 43 4D 44 03 06 00 XX CF

	Touch unlock	FE 09 58 42 48 43 4D 44 03 06 01 CF	FE 0A 58 42 48 43 4D 44 03 06 01 XX CF
	Get touch status	FE 08 58 42 48 43 4D 44 03 06 CF	FE 09 58 42 48 43 4D 44 03 06 XX CF
	Get touch MCU firmware version	FE 08 58 42 48 43 4D 44 02 25 CF	FE LL 58 42 48 43 4D 44 02 25 X1 X2 ... Xn CF

6. Troubleshooting

Symptom	Troubleshooting Methods
The screen cannot be powered on or the power indicator light is off.	Check whether the power supply is connected.
	Check whether the power supply plug is properly connected.
	Check whether the power outlet has electricity.
	Check whether the rocker switch is enabled.
	Press the reset switch and start the system again.
The remote control is not causing a response.	Replace the batteries.
	Check whether the polarity direction of the batteries is correct.
	Align the remote control with the IR receiver window. For details, see section "Remote Control".
The image is normal but there is no sound.	Increase volume on both the screen and the Windows system.
	Check whether the screen and the Windows system are muted.
	If an external computer is connected, check whether the connection cables are normal.
The system is automatically powered on/off when no operation is being performed.	Disable the automatic power-on/off function. For details, see section "Power ON/OFF Setting".
	Check whether the screen entered shut down mode due to no operation for an extended period of time.
	Check whether the input power supply is stable.
The colors of images are abnormal.	Check whether the HDMI cable is properly connected or has any quality issue.
The touch function is abnormal or the positioning is inaccurate.	Restart the screen.
	In the Windows system, recalibrate the screen. For details, see section "Calibration".
The touch function is unavailable	Switch between different external signal sources.

when the external signal source channel is being used.	Ensure that the USB touch cable is connected to the proper port. For details, see section "Ports".
	Remove and insert the USB touch cable again.
There is no sound when the HDMI in channel is used.	Remove and insert the HDMI cable again.
No image is displayed when the HDMI out channel is used.	Generally, this issue is caused by the compatibility of the external display product. Replace the external display product and test again.
	The HDMI cable is too long or has a poor quality. Replace the HDMI cable delivered with the product.
The touch function on the front panel is ineffective.	Touch the button using your full fingertip.
	Check whether the finger is wet or has other liquids on it.
	Restart the screen.
The USB flash drive cannot be identified.	Check whether the USB flash drive is inserted into the correct USB port. For details, see section "Ports."
The conference records cannot be saved on the USB flash drive, and the system prompts "The target storage product has no write permissions."	Format the USB flash drive to the FAT32 format.
The OPS has no signal.	Check whether the OPS is properly inserted in the slot.
	Check whether the OPS is in shut down mode.
	Press the power button on the OPS (for details, see the instructions of the OPS), and manually start up the OPS.
In the embedded operating system or Windows system, no wireless network can be found or the wireless network signal is weak.	Check whether the Wi-Fi antenna is properly installed on the embedded operating system. For details, see section "Ports".
	Check whether the Wi-Fi antenna is properly installed for the OPS.
The keyboard is not correctly displayed.	Confirm that the hardware keyboard is enabled.

<p>When you connect a handheld microphone to a port on the front panel, the distance from user to microphone should be no less than 1 meter, otherwise the sound may distort.</p>	<p>The front panel doesn't support handheld microphone, and needs to use the fixed microphone. To make sure of the sound quality, the distance from user to microphone should be no less than one meter.</p>
<p>When the touch screen connects to CEC facilities and powers down, touch screen will stay in shut down mode after power restart. CEC facilities can't recall the touch screen.</p>	<p>Please use the remote control to start and turn off the touch screen. Then you can use the CEC facilities to recall it.</p>

This is the general user manual for TB1300 Pro interactive flat panel display. Some details may be different from the actual product.

 IQ Board Australia

 6 Lakewood Blvd, Carrum Downs Victoria, 3201 AUSTRALIA

 1300 472 627 (1300 IQBOARD)

 www.iqboard.com.au

 enquiries@iqboard.com.au